

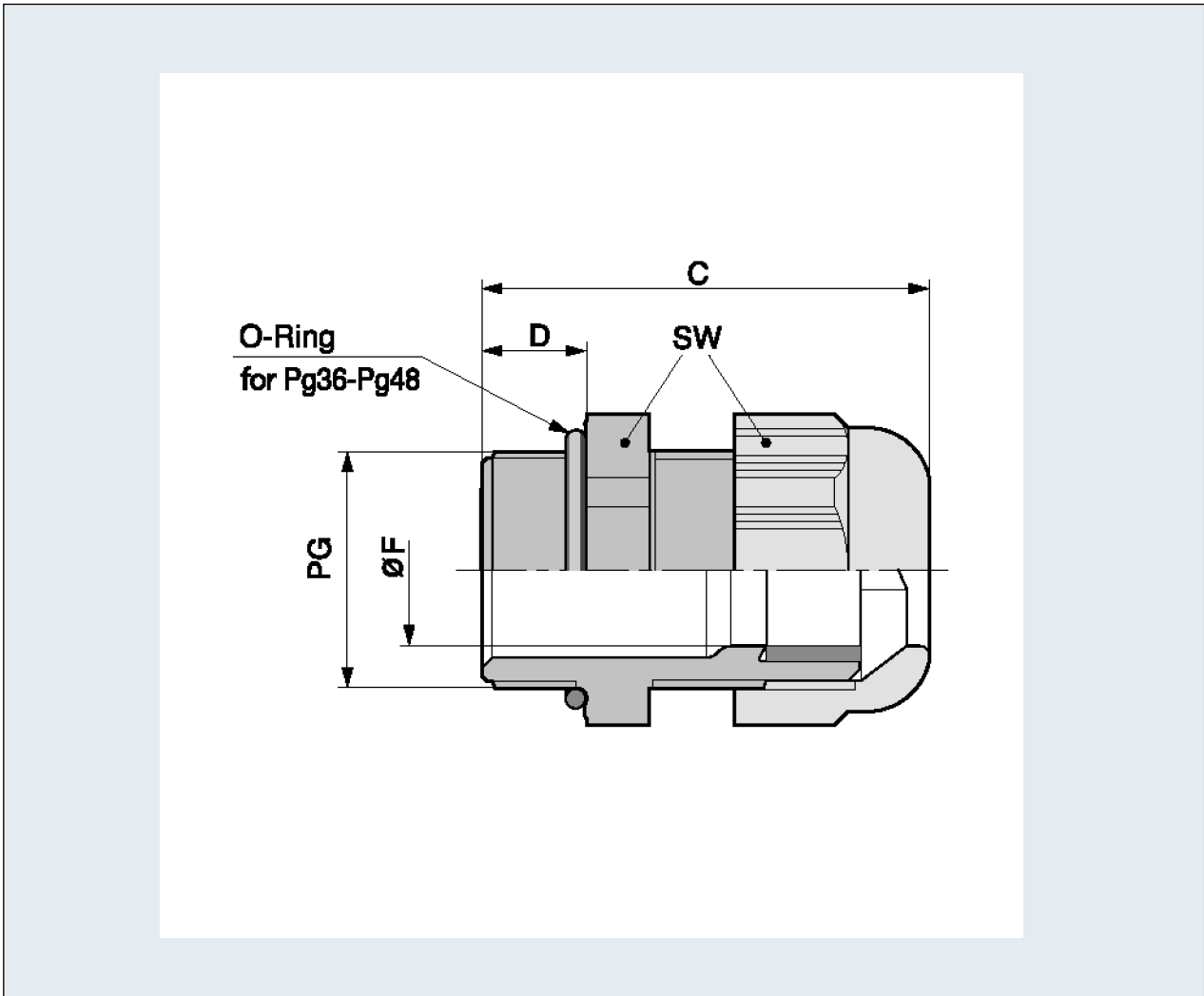

# Kabelverschraubung Kunststoff SKINTOP® ST

## PDF DATASHEET

© 1992 - 2010 CADENAS GmbH

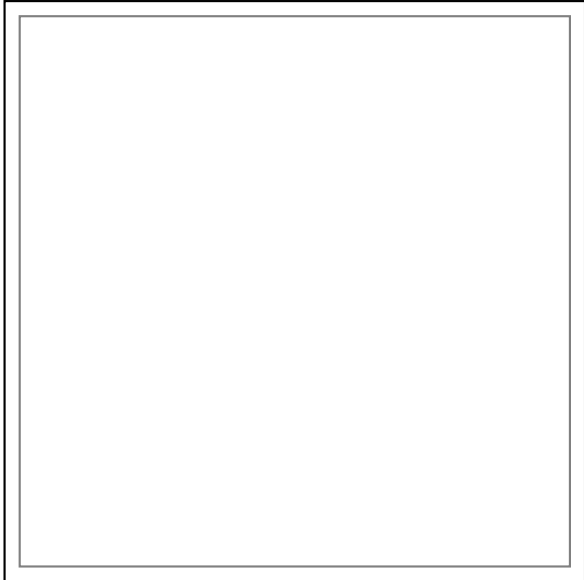
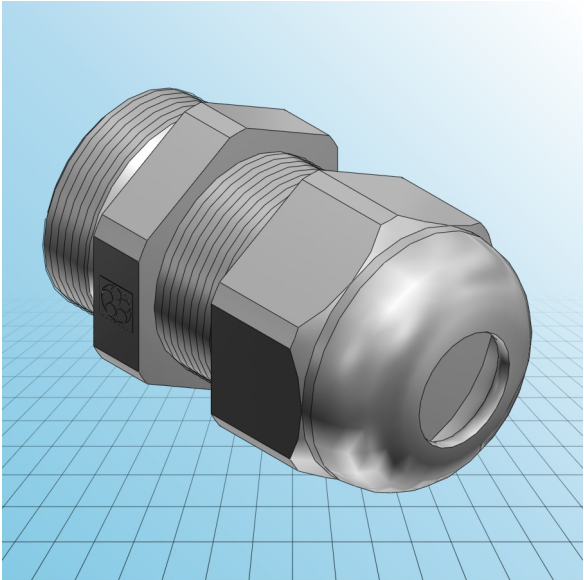



## Kabelverschraubung Kunststoff SKINTOP® ST

## PDF DATASHEET

© 1992 - 2010 CADENAS GmbH

<b>IDNR (Identnummer)</b>	
<b>ATN (Artikelnummer)</b>	53015220
<b>PG (Gewinde)</b>	PG 11
<b>FMIN (Klemmbereich min. / mm)</b>	4
<b>FMAX (Klemmbereich max. / mm)</b>	10
<b>F (Kabeldurchmesser / mm)</b>	4
<b>SW (Schlüsselweite / mm)</b>	22
<b>A (Eckmass / mm)</b>	24.4
<b>C (mm)</b>	38
<b>D (mm)</b>	8
<b>RAL7001 (Silbergrau)</b>	
<b>RAL7035 (Lichtgrau)</b>	
<b>RAL9005 (Tiefschwarz)</b>	X
<b>MATERIAL (Material)</b>	Kunststoff