

RoHS  Compliant

[BOMcheck.net](https://www.bomcheck.net)

Farbe: ■

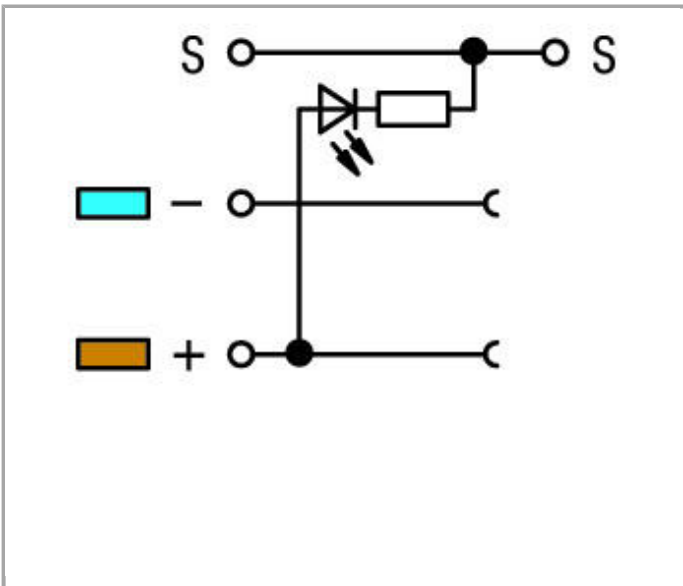

## Daten

### Elektrische Daten

Art der Spannung 1

DC

Nominalspannung

24 V

## Anschlussdaten

Anschluss technik	CAGE CLAMP®
Betätigungsart	Betätigungswerkzeug
Anschließbare Leiterwerkstoffe	Kupfer Aluminium
Eindrähtiger Leiter	0,08 ... 2,5 mm <sup>2</sup> / 28 ... 12 AWG
Feindrähtiger Leiter	0,08 ... 2,5 mm <sup>2</sup> / 28 ... 12 AWG
Abisolierlänge	6 ... 7 mm / 0.24 ... 0.28 inch
Gesamte Anzahl der Klemmstellen	4
Gesamte Anzahl der Potentiale	3
Anzahl der Ebenen	3
Verdrahtungsart	Frontverdrahtung

## Geometrische Daten

Breite	5 mm / 0.197 inch
Höhe ab Oberkante Tragschiene	39 mm / 1.535 inch
Tiefe	68 mm / 2.677 inch

## Mechanische Daten

Bauform	horizontale Bauform
Montageart	Tragschiene 35
Beschriftungsebene	Seitliche Beschriftung

## Werkstoffdaten



Farbe	grau
Brandlast	0.179 MJ
Gewicht	9.16 g

## Kaufmännische Daten

Ursprungsland	CN
GTIN	4045454193751
Zolltarifnummer	85369010000
Produktgruppe	1 (Reihenklemmen)
eCl@ss 9.0	27-14-11-28
eCl@ss 8.0	27-14-11-28
ETIM 6.0	EC000900
ETIM 5.0	EC000900

## Zulassungen / Zertifikate

### Länderspezifische Zulassungen

Logo	Zulassung	Zertifikatsname
	<b>CCA</b> DEKRA Certification B.V.	NTR NL 6828
	<b>CCA</b> DEKRA Certification B.V.	2143311.03
	<b>CSA</b> DEKRA Certification B.V.	1565649

### UL-Zulassungen





Logo	Zulassung	Zertifikatsname
	<b>UR</b> Underwriters Laboratories Inc.	E45172









## Passende Produkte

### Brücker

	<b>Art-Nr.: 270-409</b> Brücker; blank; 9-fach; Nennstrom 18 A	<a href="http://www.wago.com/270-409">www.wago.com/270-409</a>
	<b>Art-Nr.: 270-417</b> Brücker; blank; 17-fach; Nennstrom 18 A	<a href="http://www.wago.com/270-417">www.wago.com/270-417</a>
	<b>Art-Nr.: 270-480</b> Brücker; blank; 80-fach; Nennstrom 18 A	<a href="http://www.wago.com/270-480">www.wago.com/270-480</a>

### Aderendhülse

	<b>Art-Nr.: 216-121</b> Aderendhülse; Hülse für 0,5 mm <sup>2</sup> / AWG 22; ohne Kunststoffkragen; galvanisch verzinkt	<a href="http://www.wago.com/216-121">www.wago.com/216-121</a>
	<b>Art-Nr.: 216-122</b> Aderendhülse; Hülse für 0,75 mm <sup>2</sup> / AWG 20; ohne Kunststoffkragen; galvanisch verzinkt	<a href="http://www.wago.com/216-122">www.wago.com/216-122</a>
	<b>Art-Nr.: 216-123</b> Aderendhülse; Hülse für 1 mm <sup>2</sup> / AWG 18; ohne Kunststoffkragen; galvanisch verzinkt	<a href="http://www.wago.com/216-123">www.wago.com/216-123</a>
	<b>Art-Nr.: 216-124</b> Aderendhülse; Hülse für 1,5 mm <sup>2</sup> / AWG 16; ohne Kunststoffkragen; galvanisch verzinkt	<a href="http://www.wago.com/216-124">www.wago.com/216-124</a>

	<b>Art-Nr.: 216-131</b> Aderendhülse; Hülse für 0,25 mm <sup>2</sup> / AWG 24; ohne Kunststoffkragen; galvanisch verzinkt	<a href="http://www.wago.com/216-131">www.wago.com/216-131</a>
	<b>Art-Nr.: 216-132</b> Aderendhülse; Hülse für 0,34 mm <sup>2</sup> / AWG 24; ohne Kunststoffkragen; galvanisch verzinkt	<a href="http://www.wago.com/216-132">www.wago.com/216-132</a>
	<b>Art-Nr.: 216-221</b> Aderendhülse; Hülse für 0,5 mm <sup>2</sup> / AWG 22; mit Kunststoffkragen; galvanisch verzinkt	<a href="http://www.wago.com/216-221">www.wago.com/216-221</a>
	<b>Art-Nr.: 216-222</b> Aderendhülse; Hülse für 0,75 mm <sup>2</sup> / AWG 20; mit Kunststoffkragen; galvanisch verzinkt	<a href="http://www.wago.com/216-222">www.wago.com/216-222</a>
	<b>Art-Nr.: 216-223</b> Aderendhülse; Hülse für 1 mm <sup>2</sup> / AWG 18; mit Kunststoffkragen; galvanisch verzinkt	<a href="http://www.wago.com/216-223">www.wago.com/216-223</a>
	<b>Art-Nr.: 216-224</b> Aderendhülse; Hülse für 1,5 mm <sup>2</sup> / AWG 16; mit Kunststoffkragen; galvanisch verzinkt	<a href="http://www.wago.com/216-224">www.wago.com/216-224</a>
	<b>Art-Nr.: 216-321</b> Aderendhülse; Hülse für 0,25 mm <sup>2</sup> / AWG 24; mit Kunststoffkragen; galvanisch verzinkt	<a href="http://www.wago.com/216-321">www.wago.com/216-321</a>
	<b>Art-Nr.: 216-322</b> Aderendhülse; Hülse für 0,34 mm <sup>2</sup> / AWG 24; mit Kunststoffkragen; galvanisch verzinkt	<a href="http://www.wago.com/216-322">www.wago.com/216-322</a>



#### Abschlussplatte

	<b>Art-Nr.: 270-319</b> Abschluss- und Zwischenplatte; 1 mm dick; für Dreistockklemmen	<a href="http://www.wago.com/270-319">www.wago.com/270-319</a>
	<b>Art-Nr.: 270-321</b> Abschluss- und Zwischenplatte; 1 mm dick; für Dreistockklemmen	<a href="http://www.wago.com/270-321">www.wago.com/270-321</a>

#### Werkzeug















	<b>Art-Nr.: 210-657</b> Betätigungswerkzeug mit teilisoliertem Schaft; Klinge (3,5 x 0,5) mm; kurz	<a href="http://www.wago.com/210-657">www.wago.com/210-657</a>
	<b>Art-Nr.: 210-720</b> Betätigungswerkzeug mit teilisoliertem Schaft; Typ 2, Klinge (3,5 x 0,5) mm	<a href="http://www.wago.com/210-720">www.wago.com/210-720</a>

















#### Isolierungs-Stopp

	<b>Art-Nr.: 280-470</b> Isolierungsstopp; 0,08 - 0,2 mm <sup>2</sup> "e" (0,14 mm <sup>2</sup> "f"); 5 Stück / Strang	<a href="http://www.wago.com/280-470">www.wago.com/280-470</a>
	<b>Art-Nr.: 280-471</b> Isolierungsstopp; 0,25 - 0,5 mm <sup>2</sup> ; 5 Stück / Strang	<a href="http://www.wago.com/280-471">www.wago.com/280-471</a>
	<b>Art-Nr.: 280-472</b> Isolierungsstopp; 0,75 - 1 mm <sup>2</sup> ; 5 Stück / Strang	<a href="http://www.wago.com/280-472">www.wago.com/280-472</a>

#### Beschriftungsmaterial

	<b>Art-Nr.: 2009-115</b> WMB-Inline; für smartPRINTER; auf Rolle; dehnbar 5 - 5,2 mm; unbedruckt; aufrastbar	<a href="http://www.wago.com/2009-115">www.wago.com/2009-115</a>
	<b>Art-Nr.: 2009-115/000-002</b> WMB-Inline; für smartPRINTER; auf Rolle; dehnbar 5 - 5,2 mm; unbedruckt; aufrastbar	<a href="http://www.wago.com/2009-115/000-002">www.wago.com/2009-115/000-002</a>

	<b>Art-Nr.: 2009-115/000-006</b> WMB-Inline; für smartPRINTER; auf Rolle; dehnbar 5 - 5,2 mm; unbedruckt; aufrastbar	<a href="http://www.wago.com/2009-115/000-006">www.wago.com/2009-115/000-006</a>
	<b>Art-Nr.: 2009-115/000-007</b> WMB-Inline; für smartPRINTER; auf Rolle; dehnbar 5 - 5,2 mm; unbedruckt; aufrastbar	<a href="http://www.wago.com/2009-115/000-007">www.wago.com/2009-115/000-007</a>
	<b>Art-Nr.: 2009-115/000-012</b> WMB-Inline; für smartPRINTER; auf Rolle; dehnbar 5 - 5,2 mm; unbedruckt; aufrastbar	<a href="http://www.wago.com/2009-115/000-012">www.wago.com/2009-115/000-012</a>
	<b>Art-Nr.: 2009-115/000-017</b> WMB-Inline; für smartPRINTER; auf Rolle; dehnbar 5 - 5,2 mm; unbedruckt; aufrastbar	<a href="http://www.wago.com/2009-115/000-017">www.wago.com/2009-115/000-017</a>
	<b>Art-Nr.: 2009-115/000-023</b> WMB-Inline; für smartPRINTER; auf Rolle; dehnbar 5 - 5,2 mm; unbedruckt; aufrastbar	<a href="http://www.wago.com/2009-115/000-023">www.wago.com/2009-115/000-023</a>
	<b>Art-Nr.: 2009-115/000-024</b> WMB-Inline; für smartPRINTER; auf Rolle; dehnbar 5 - 5,2 mm; unbedruckt; aufrastbar	<a href="http://www.wago.com/2009-115/000-024">www.wago.com/2009-115/000-024</a>
	<b>Art-Nr.: 2009-145</b> Mini-WSB Inline; für smartPRINTER; auf Rolle; dehnbar 5 - 5,2 mm; unbedruckt; aufrastbar	<a href="http://www.wago.com/2009-145">www.wago.com/2009-145</a>
	<b>Art-Nr.: 2009-145/000-002</b> Mini-WSB Inline; für smartPRINTER; auf Rolle; dehnbar 5 - 5,2 mm; unbedruckt; aufrastbar	<a href="http://www.wago.com/2009-145/000-002">www.wago.com/2009-145/000-002</a>
	<b>Art-Nr.: 2009-145/000-005</b> Mini-WSB Inline; für smartPRINTER; auf Rolle; dehnbar 5 - 5,2 mm; unbedruckt; aufrastbar	<a href="http://www.wago.com/2009-145/000-005">www.wago.com/2009-145/000-005</a>
	<b>Art-Nr.: 2009-145/000-006</b> Mini-WSB Inline; für smartPRINTER; auf Rolle; dehnbar 5 - 5,2 mm; unbedruckt; aufrastbar	<a href="http://www.wago.com/2009-145/000-006">www.wago.com/2009-145/000-006</a>
	<b>Art-Nr.: 2009-145/000-007</b> Mini-WSB Inline; für smartPRINTER; auf Rolle; dehnbar 5 - 5,2 mm; unbedruckt; aufrastbar	<a href="http://www.wago.com/2009-145/000-007">www.wago.com/2009-145/000-007</a>
	<b>Art-Nr.: 2009-145/000-012</b> Mini-WSB Inline; für smartPRINTER; auf Rolle; dehnbar 5 - 5,2 mm; unbedruckt; aufrastbar	<a href="http://www.wago.com/2009-145/000-012">www.wago.com/2009-145/000-012</a>
	<b>Art-Nr.: 2009-145/000-023</b> Mini-WSB Inline; für smartPRINTER; auf Rolle; dehnbar 5 - 5,2 mm; unbedruckt; aufrastbar	<a href="http://www.wago.com/2009-145/000-023">www.wago.com/2009-145/000-023</a>
	<b>Art-Nr.: 2009-145/000-024</b> Mini-WSB Inline; auf Rolle; dehnbar 5 - 5,2 mm; unbedruckt; aufrastbar	<a href="http://www.wago.com/2009-145/000-024">www.wago.com/2009-145/000-024</a>
	<b>Art-Nr.: 248-501</b>	

	Mini-WSB-Schnellbeschriftungssystem; unbedruckt; Schildchenbreite 5 mm; 10 Streifen à 10 Schilder pro Karte	<a href="http://www.wago.com/248-501">www.wago.com/248-501</a>
	<b>Art-Nr.: 248-501/000-002</b> Mini-WSB-Beschriftungskarte; als Karte; nicht dehnbar; unbedruckt; aufrastbar	<a href="http://www.wago.com/248-501/000-002">www.wago.com/248-501/000-002</a>
	<b>Art-Nr.: 248-501/000-005</b> Mini-WSB-Beschriftungskarte; als Karte; unbedruckt; aufrastbar	<a href="http://www.wago.com/248-501/000-005">www.wago.com/248-501/000-005</a>
	<b>Art-Nr.: 248-501/000-006</b> Mini-WSB-Beschriftungskarte; als Karte; nicht dehnbar; unbedruckt; aufrastbar	<a href="http://www.wago.com/248-501/000-006">www.wago.com/248-501/000-006</a>
	<b>Art-Nr.: 248-501/000-007</b> Mini-WSB-Beschriftungskarte; als Karte; nicht dehnbar; unbedruckt; aufrastbar	<a href="http://www.wago.com/248-501/000-007">www.wago.com/248-501/000-007</a>
	<b>Art-Nr.: 248-501/000-012</b> Mini-WSB-Beschriftungskarte; als Karte; nicht dehnbar; unbedruckt; aufrastbar	<a href="http://www.wago.com/248-501/000-012">www.wago.com/248-501/000-012</a>
	<b>Art-Nr.: 248-501/000-017</b> Mini-WSB-Beschriftungskarte; als Karte; nicht dehnbar; unbedruckt; aufrastbar	<a href="http://www.wago.com/248-501/000-017">www.wago.com/248-501/000-017</a>
	<b>Art-Nr.: 248-501/000-023</b> Mini-WSB-Beschriftungskarte; als Karte; nicht dehnbar; unbedruckt; aufrastbar	<a href="http://www.wago.com/248-501/000-023">www.wago.com/248-501/000-023</a>
	<b>Art-Nr.: 248-501/000-024</b> Mini-WSB-Beschriftungskarte; als Karte; nicht dehnbar; unbedruckt; aufrastbar	<a href="http://www.wago.com/248-501/000-024">www.wago.com/248-501/000-024</a>
	<b>Art-Nr.: 709-177</b> Beschriftungsstreifen; auf Rolle; 7,5 mm breit; nicht dehnbar; unbedruckt; aufrastbar	<a href="http://www.wago.com/709-177">www.wago.com/709-177</a>
	<b>Art-Nr.: 709-178</b> Beschriftungsstreifen; auf Rolle; 7,5 mm breit; nicht dehnbar; unbedruckt; aufrastbar	<a href="http://www.wago.com/709-178">www.wago.com/709-178</a>
	<b>Art-Nr.: 709-196</b> Beschriftungsstreifen; für Laserdrucker	<a href="http://www.wago.com/709-196">www.wago.com/709-196</a>
	<b>Art-Nr.: 793-501</b> WMB-Beschriftungskarte; als Karte; nicht dehnbar; unbedruckt; aufrastbar	<a href="http://www.wago.com/793-501">www.wago.com/793-501</a>
	<b>Art-Nr.: 793-501/000-002</b> WMB-Beschriftungskarte; als Karte; nicht dehnbar; unbedruckt; aufrastbar	<a href="http://www.wago.com/793-501/000-002">www.wago.com/793-501/000-002</a>
	<b>Art-Nr.: 793-501/000-005</b> WMB-Beschriftungskarte; als Karte; nicht dehnbar; unbedruckt; aufrastbar	<a href="http://www.wago.com/793-501/000-005">www.wago.com/793-501/000-005</a>
	<b>Art-Nr.: 793-501/000-006</b> WMB-Beschriftungskarte; als Karte; nicht dehnbar; unbedruckt; aufrastbar	<a href="http://www.wago.com/793-501/000-006">www.wago.com/793-501/000-006</a>



**Art-Nr.: 793-501/000-007**  
WMB-Beschriftungskarte; als Karte; nicht dehnbar; unbedruckt; aufrastbar

[www.wago.com/793-501/000-007](http://www.wago.com/793-501/000-007)



**Art-Nr.: 793-501/000-012**  
WMB-Beschriftungskarte; als Karte; nicht dehnbar; unbedruckt; aufrastbar

[www.wago.com/793-501/000-012](http://www.wago.com/793-501/000-012)



**Art-Nr.: 793-501/000-017**  
WMB-Beschriftungskarte; als Karte; nicht dehnbar; unbedruckt; aufrastbar

[www.wago.com/793-501/000-017](http://www.wago.com/793-501/000-017)



**Art-Nr.: 793-501/000-023**  
WMB-Beschriftungskarte; als Karte; nicht dehnbar; unbedruckt; aufrastbar

[www.wago.com/793-501/000-023](http://www.wago.com/793-501/000-023)



**Art-Nr.: 793-501/000-024**  
WMB-Beschriftungskarte; als Karte; nicht dehnbar; unbedruckt; aufrastbar

[www.wago.com/793-501/000-024](http://www.wago.com/793-501/000-024)



**Art-Nr.: 793-5501**  
WMB-Beschriftungskarte; als Karte; für Klemmenbreite 5 - 17,5 mm; dehnbar 5 - 5,2 mm; unbedruckt; aufrastbar

[www.wago.com/793-5501](http://www.wago.com/793-5501)



**Art-Nr.: 793-5501/000-002**  
WMB-Beschriftungskarte; als Karte; für Klemmenbreite 5 - 17,5 mm; dehnbar 5 - 5,2 mm; unbedruckt; aufrastbar

[www.wago.com/793-5501/000-002](http://www.wago.com/793-5501/000-002)



**Art-Nr.: 793-5501/000-005**  
WMB-Beschriftungskarte; als Karte; dehnbar 5 - 5,2 mm; unbedruckt; aufrastbar

[www.wago.com/793-5501/000-005](http://www.wago.com/793-5501/000-005)



**Art-Nr.: 793-5501/000-006**  
WMB-Beschriftungskarte; als Karte; dehnbar 5 - 5,2 mm; unbedruckt; aufrastbar

[www.wago.com/793-5501/000-006](http://www.wago.com/793-5501/000-006)



**Art-Nr.: 793-5501/000-007**  
WMB-Beschriftungskarte; als Karte; dehnbar 5 - 5,2 mm; unbedruckt; aufrastbar

[www.wago.com/793-5501/000-007](http://www.wago.com/793-5501/000-007)



**Art-Nr.: 793-5501/000-012**  
WMB-Beschriftungskarte; als Karte; dehnbar 5 - 5,2 mm; unbedruckt; aufrastbar

[www.wago.com/793-5501/000-012](http://www.wago.com/793-5501/000-012)



**Art-Nr.: 793-5501/000-017**  
WMB-Beschriftungskarte; als Karte; dehnbar 5 - 5,2 mm; unbedruckt; aufrastbar

[www.wago.com/793-5501/000-017](http://www.wago.com/793-5501/000-017)



**Art-Nr.: 793-5501/000-023**  
WMB-Beschriftungskarte; als Karte; dehnbar 5 - 5,2 mm; unbedruckt; aufrastbar

[www.wago.com/793-5501/000-023](http://www.wago.com/793-5501/000-023)



**Art-Nr.: 793-5501/000-024**  
WMB-Beschriftungskarte; als Karte; dehnbar 5 - 5,2 mm; unbedruckt; aufrastbar

[www.wago.com/793-5501/000-024](http://www.wago.com/793-5501/000-024)



Downloads

Dokumentation

Ausschreibungstext

---

270-560/281-507	Oct 11, 2017	DOC 24,6 kB	Download
-----------------	--------------	----------------	----------

---

smartDATA

CAD Daten

---

3D Download 270-560/281-507	URL	Download
-----------------------------	-----	----------

---

Änderungen vorbehalten.

---

WAGO Kontakttechnik GmbH & Co. KG  
Hansastr. 27  
32423 Minden  
Telefon: +49571 887-0  
E-Mail: [info.de@wago.com](mailto:info.de@wago.com) | Web: [www.wago.com](http://www.wago.com)

Haben Sie Fragen zu unseren Produkten?  
Wir stehen Ihnen telefonisch unter +49 (571) 887-44222 gern zur  
Verfügung.