

Product Description

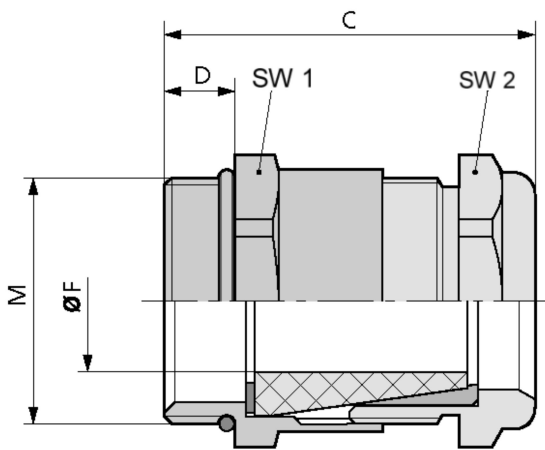

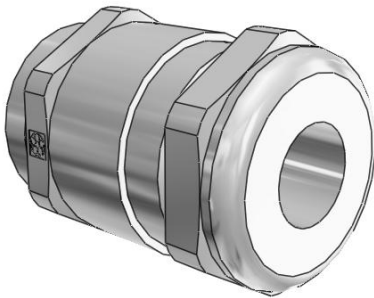

**Technical Data**

ATN	52105330
M	M 20x1,5
FMIN	9
FMAX	10.8
F	9
SW1	22
A1	24.4
SW2	22
A2	24.4
C	32.5
D	6
MATERIAL	Messing vernickelt