

Datenblatt | Artikelnummer: 235-766/331-000

Anreihbare Leiterplattenklemme; Drücker; 1,5 mm<sup>2</sup>; Rastermaß 10/10,16 mm; 1-polig; Push-in CAGE CLAMP®

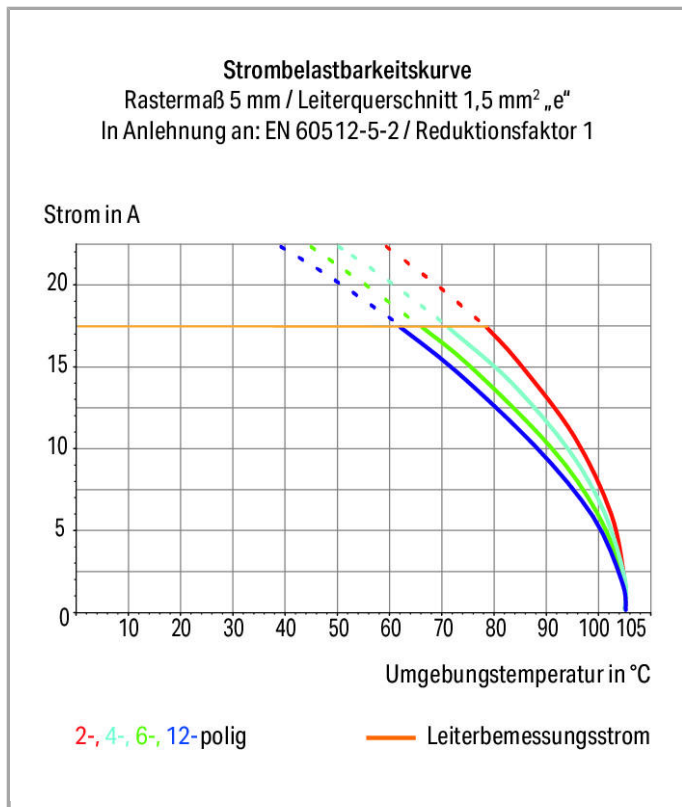

[www.wago.com/235-766/331-000](http://www.wago.com/235-766/331-000)



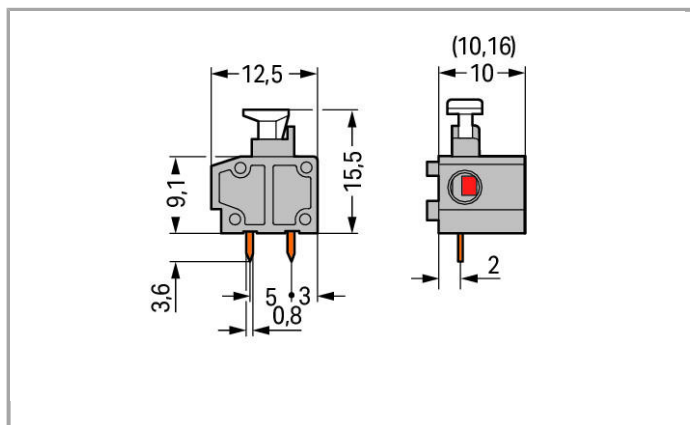

### Artikelbeschreibung

- Einzelklemmen mit Drückern zur Konfektionierung individueller Klemmenleisten
- Eindräftige Leiter und feindräftige Leiter mit Aderendhülsen direkt steckbar
- Komfortable Drückerbetätigung für das Anschließen von feindräftigen Leitern und das Lösen von Leiter
- Einstellung zwischen den beiden Rastermaßen durch Zusammendrücken oder Auseinanderziehen der Klemmenleisten

Weitere Varianten können über den WAGO Vertrieb angefragt oder ggfs. unter <https://configurator.wago.com> konfiguriert werden: Andere Farben, Varianten für Ex i

### Daten

#### Elektrische Daten

#### Bemessungsdaten gemäß IEC/EN 60664-1

|                                  |                                                               |
|----------------------------------|---------------------------------------------------------------|
| Bemessungsspannung (III / 3)     | 630 V                                                         |
| Bemessungsstoßspannung (III / 3) | 8 kV                                                          |
| Bemessungsspannung (III / 2)     | 1000 V                                                        |
| Bemessungsstoßspannung (III / 2) | 8 kV                                                          |
| Bemessungsspannung (II / 2)      | 1000 V                                                        |
| Bemessungsstoßspannung (II / 2)  | 8 kV                                                          |
| Bemessungsstrom                  | 17.5 A                                                        |
| Legende Bemessungsdaten          | (III / 2) ≙ Überspannungskategorie III / Verschmutzungsgrad 2 |

#### Bemessungsdaten gemäß UL 1059

|                                     |       |
|-------------------------------------|-------|
| Bemessungsspannung UL (Use Group B) | 300 V |
| Bemessungsstrom UL (Use Group B)    | 10 A  |
| Bemessungsspannung UL (Use Group D) | 300 V |
| Bemessungsstrom UL (Use Group D)    | 10 A  |



## Bemessungsdaten gemäß CSA

|                                      |       |
|--------------------------------------|-------|
| Bemessungsspannung CSA (Use Group B) | 300 V |
| Bemessungsstrom CSA (Use Group B)    | 15 A  |

## Anschlussdaten

|                                                              |                                              |
|--------------------------------------------------------------|----------------------------------------------|
| Anschluss technik                                            | Push-in CAGE CLAMP®                          |
| Betätigungsart                                               | Drücker                                      |
| Eindrähtiger Leiter                                          | 0,2 ... 1,5 mm <sup>2</sup> / 20 ... 14 AWG  |
| Feindrähtiger Leiter                                         | 0,75 ... 1,5 mm <sup>2</sup> / 20 ... 14 AWG |
| Feindrähtiger Leiter; mit Aderendhülse mit Kunststoffkragen  | 0,25 ... 1 mm <sup>2</sup>                   |
| Feindrähtiger Leiter; mit Aderendhülse ohne Kunststoffkragen | 0,25 ... 1 mm <sup>2</sup>                   |
| Abisolierlänge                                               | 9 ... 10 mm / 0.35 ... 0.39 inch             |
| Leiteranschlussrichtung zur Leiterplatte                     | 0°                                           |
| Polzahl                                                      | 1                                            |
| Gesamte Anzahl der Klemmstellen                              | 1                                            |
| Gesamte Anzahl der Potentiale                                | 1                                            |
| Anzahl Anschlusstypen                                        | 1                                            |
| Anzahl der Ebenen                                            | 1                                            |

## Geometrische Daten

|                                  |                              |
|----------------------------------|------------------------------|
| Rastermaß                        | 10/10,16 mm / 0.394/0.4 inch |
| Breite                           | 11,5 mm / 0.453 inch         |
| Höhe                             | 19,1 mm / 0.752 inch         |
| Höhe ab Oberfläche               | 15,5 mm / 0.61 inch          |
| Tiefe                            | 12,5 mm / 0.492 inch         |
| Lötstiftlänge                    | 3.6 mm                       |
| Lötstiftabmessungen              | 0,4 x 0,8 mm                 |
| Bohrlochdurchmesser mit Toleranz | 1 <sup>(+ 0,1)</sup> mm      |

## Leiterplattenkontaktierung

|                                    |                               |
|------------------------------------|-------------------------------|
| Leiterplattenkontaktierung         | THT                           |
| Lötstifanordnung                   | innerhalb der Klemme in Reihe |
| Anzahl der Lötstifte pro Potential | 2                             |

## Werkstoffdaten

|                    |                     |
|--------------------|---------------------|
| Farbe              | orange              |
| Isolierstoffgruppe | I                   |
| Isolierwerkstoff   | Polyamid 66 (PA 66) |

|                                 |                                |
|---------------------------------|--------------------------------|
| Brennbarkeitsklasse gemäß UL 94 | V0                             |
| Klemmfederwerkstoff             | Chrom-Nickel-Federstahl (CrNi) |
| Kontaktwerkstoff                | Elektrolytkupfer (Ecu)         |
| Kontaktoberfläche               | verzinkt                       |
| Brandlast                       | 0.023 MJ                       |
| Gewicht                         | 1.063 g                        |

## Umgebungsbedingungen

|                        |                 |
|------------------------|-----------------|
| Grenztemperaturbereich | -60 ... +105 °C |
|------------------------|-----------------|

## Kaufmännische Daten

|                 |                                   |
|-----------------|-----------------------------------|
| Ursprungsland   | CH                                |
| GTIN            | 4044918832854                     |
| Zolltarifnummer | 85369010000                       |
| Produktgruppe   | 4 (GDS- und Durchführungsklemmen) |
| eCl@ss 9.0      | 27-44-04-01                       |
| eCl@ss 8.0      | 27-44-04-01                       |
| ETIM 6.0        | EC002643                          |
| ETIM 5.0        | EC002643                          |

## Zulassungen / Zertifikate

### Länderspezifische Zulassungen







| Logo                                                                               | Zulassung                                    | Zertifikatsname |
|------------------------------------------------------------------------------------|----------------------------------------------|-----------------|
|  | CCA<br>DEKRA Certification B.V.              | NTR NL-7144     |
|  | CCA<br>DEKRA Certification B.V.              | 2149549.02      |
|  | CCA<br>DEKRA Certification B.V.              | NTR NL 6919     |
|  | CCA<br>DEKRA Certification B.V.              | NTR NL-7625     |
|  | VDE<br>VDE Prüf- und Zertifizierungsinstitut | 40029328        |

## Schiff Zulassungen



| Logo                                                                             | Zulassung                                               | Zertifikatsname |
|----------------------------------------------------------------------------------|---------------------------------------------------------|-----------------|
|  | <b>DNV GL</b><br>Det Norske Veritas, Germanischer Lloyd | TAE000016Z      |

## Passende Produkte

## Abschlussplatte

|                                                                                    |                                                                  |                                                                |
|------------------------------------------------------------------------------------|------------------------------------------------------------------|----------------------------------------------------------------|
|    | <b>Art-Nr.: 235-100</b><br>Abschlussplatte; anrastbar; 1 mm dick | <a href="http://www.wago.com/235-100">www.wago.com/235-100</a> |
|    | <b>Art-Nr.: 235-200</b><br>Abschlussplatte; anrastbar; 1 mm dick | <a href="http://www.wago.com/235-200">www.wago.com/235-200</a> |
|    | <b>Art-Nr.: 235-300</b><br>Abschlussplatte; anrastbar; 1 mm dick | <a href="http://www.wago.com/235-300">www.wago.com/235-300</a> |
|    | <b>Art-Nr.: 235-400</b><br>Abschlussplatte; anrastbar; 1 mm dick | <a href="http://www.wago.com/235-400">www.wago.com/235-400</a> |
|   | <b>Art-Nr.: 235-500</b><br>Abschlussplatte; anrastbar; 1 mm dick | <a href="http://www.wago.com/235-500">www.wago.com/235-500</a> |
|  | <b>Art-Nr.: 235-550</b><br>Abschlussplatte; anrastbar; 1 mm dick | <a href="http://www.wago.com/235-550">www.wago.com/235-550</a> |
|  | <b>Art-Nr.: 235-600</b><br>Abschlussplatte; anrastbar; 1 mm dick | <a href="http://www.wago.com/235-600">www.wago.com/235-600</a> |
|  | <b>Art-Nr.: 235-650</b><br>Abschlussplatte; anrastbar; 1 mm dick | <a href="http://www.wago.com/235-650">www.wago.com/235-650</a> |
|  | <b>Art-Nr.: 235-700</b><br>Abschlussplatte; anrastbar; 1 mm dick | <a href="http://www.wago.com/235-700">www.wago.com/235-700</a> |
|  | <b>Art-Nr.: 235-800</b><br>Abschlussplatte; anrastbar; 1 mm dick | <a href="http://www.wago.com/235-800">www.wago.com/235-800</a> |
|  | <b>Art-Nr.: 235-850</b><br>Abschlussplatte; anrastbar; 1 mm dick | <a href="http://www.wago.com/235-850">www.wago.com/235-850</a> |

## Beschriftungsmaterial

|                                                                                    |                                                                                                                                                                                |                                                                                  |
|------------------------------------------------------------------------------------|--------------------------------------------------------------------------------------------------------------------------------------------------------------------------------|----------------------------------------------------------------------------------|
|  | <b>Art-Nr.: 210-332/1000-202</b><br>Beschriftungsstreifen; als Bogen DIN A4; bedruckt; 1-16 (80x); Streifenhöhe 3 mm; Streifenlänge 182 mm; Aufdruck waagrecht; Selbstklebend  | <a href="http://www.wago.com/210-332/1000-202">www.wago.com/210-332/1000-202</a> |
|  | <b>Art-Nr.: 210-332/1000-204</b><br>Beschriftungsstreifen; als Bogen DIN A4; bedruckt; 17-31 (80x); Streifenhöhe 3 mm; Streifenlänge 182 mm; Aufdruck waagrecht; Selbstklebend | <a href="http://www.wago.com/210-332/1000-204">www.wago.com/210-332/1000-204</a> |

|                                                                                  |                                                                                                                                                                                |                                                                                  |
|----------------------------------------------------------------------------------|--------------------------------------------------------------------------------------------------------------------------------------------------------------------------------|----------------------------------------------------------------------------------|
|  | <b>Art-Nr.: 210-332/1000-206</b><br>Beschriftungsstreifen; als Bogen DIN A4; bedruckt; 33-48 (80x); Streifenhöhe 3 mm; Streifenlänge 182 mm; Aufdruck waagrecht; Selbstklebend | <a href="http://www.wago.com/210-332/1000-206">www.wago.com/210-332/1000-206</a> |
|----------------------------------------------------------------------------------|--------------------------------------------------------------------------------------------------------------------------------------------------------------------------------|----------------------------------------------------------------------------------|

|                                                                                  |                                                                                                                                                                               |                                                                                  |
|----------------------------------------------------------------------------------|-------------------------------------------------------------------------------------------------------------------------------------------------------------------------------|----------------------------------------------------------------------------------|
|  | <b>Art-Nr.: 210-332/1016-202</b><br>Beschriftungsstreifen; als Bogen DIN A4; bedruckt; 1-16 (80x); Streifenhöhe 3 mm; Streifenlänge 182 mm; Aufdruck waagrecht; Selbstklebend | <a href="http://www.wago.com/210-332/1016-202">www.wago.com/210-332/1016-202</a> |
|----------------------------------------------------------------------------------|-------------------------------------------------------------------------------------------------------------------------------------------------------------------------------|----------------------------------------------------------------------------------|

|                                                                                  |                                                                                                                                                                                |                                                                                  |
|----------------------------------------------------------------------------------|--------------------------------------------------------------------------------------------------------------------------------------------------------------------------------|----------------------------------------------------------------------------------|
|  | <b>Art-Nr.: 210-332/1016-204</b><br>Beschriftungsstreifen; als Bogen DIN A4; bedruckt; 17-31 (80x); Streifenhöhe 3 mm; Streifenlänge 182 mm; Aufdruck waagrecht; Selbstklebend | <a href="http://www.wago.com/210-332/1016-204">www.wago.com/210-332/1016-204</a> |
|----------------------------------------------------------------------------------|--------------------------------------------------------------------------------------------------------------------------------------------------------------------------------|----------------------------------------------------------------------------------|

|                                                                                  |                                                                                                                                                                                |                                                                                  |
|----------------------------------------------------------------------------------|--------------------------------------------------------------------------------------------------------------------------------------------------------------------------------|----------------------------------------------------------------------------------|
|  | <b>Art-Nr.: 210-332/1016-206</b><br>Beschriftungsstreifen; als Bogen DIN A4; bedruckt; 33-48 (80x); Streifenhöhe 3 mm; Streifenlänge 182 mm; Aufdruck waagrecht; Selbstklebend | <a href="http://www.wago.com/210-332/1016-206">www.wago.com/210-332/1016-206</a> |
|----------------------------------------------------------------------------------|--------------------------------------------------------------------------------------------------------------------------------------------------------------------------------|----------------------------------------------------------------------------------|

#### Allgemeines Zubehör

|                                                                                  |                                                                                  |                                                                |
|----------------------------------------------------------------------------------|----------------------------------------------------------------------------------|----------------------------------------------------------------|
|  | <b>Art-Nr.: 235-701</b><br>Rasterzwischenstück; zur Verdoppelung des Rastermaßes | <a href="http://www.wago.com/235-701">www.wago.com/235-701</a> |
|----------------------------------------------------------------------------------|----------------------------------------------------------------------------------|----------------------------------------------------------------|

#### Aderendhülse

|                                                                                  |                                                                                                                             |                                                                |
|----------------------------------------------------------------------------------|-----------------------------------------------------------------------------------------------------------------------------|----------------------------------------------------------------|
|  | <b>Art-Nr.: 216-101</b><br>Aderendhülse; Hülse für 0,5 mm <sup>2</sup> / AWG 22; ohne Kunststoffkragen; galvanisch verzinkt | <a href="http://www.wago.com/216-101">www.wago.com/216-101</a> |
|----------------------------------------------------------------------------------|-----------------------------------------------------------------------------------------------------------------------------|----------------------------------------------------------------|

|                                                                                   |                                                                                                                              |                                                                |
|-----------------------------------------------------------------------------------|------------------------------------------------------------------------------------------------------------------------------|----------------------------------------------------------------|
|  | <b>Art-Nr.: 216-102</b><br>Aderendhülse; Hülse für 0,75 mm <sup>2</sup> / AWG 20; ohne Kunststoffkragen; galvanisch verzinkt | <a href="http://www.wago.com/216-102">www.wago.com/216-102</a> |
|-----------------------------------------------------------------------------------|------------------------------------------------------------------------------------------------------------------------------|----------------------------------------------------------------|

|                                                                                    |                                                                                                                           |                                                                |
|------------------------------------------------------------------------------------|---------------------------------------------------------------------------------------------------------------------------|----------------------------------------------------------------|
|  | <b>Art-Nr.: 216-103</b><br>Aderendhülse; Hülse für 1 mm <sup>2</sup> / AWG 18; ohne Kunststoffkragen; galvanisch verzinkt | <a href="http://www.wago.com/216-103">www.wago.com/216-103</a> |
|------------------------------------------------------------------------------------|---------------------------------------------------------------------------------------------------------------------------|----------------------------------------------------------------|

|                                                                                    |                                                                                                                             |                                                                |
|------------------------------------------------------------------------------------|-----------------------------------------------------------------------------------------------------------------------------|----------------------------------------------------------------|
|  | <b>Art-Nr.: 216-121</b><br>Aderendhülse; Hülse für 0,5 mm <sup>2</sup> / AWG 22; ohne Kunststoffkragen; galvanisch verzinkt | <a href="http://www.wago.com/216-121">www.wago.com/216-121</a> |
|------------------------------------------------------------------------------------|-----------------------------------------------------------------------------------------------------------------------------|----------------------------------------------------------------|

|                                                                                    |                                                                                                                              |                                                                |
|------------------------------------------------------------------------------------|------------------------------------------------------------------------------------------------------------------------------|----------------------------------------------------------------|
|  | <b>Art-Nr.: 216-122</b><br>Aderendhülse; Hülse für 0,75 mm <sup>2</sup> / AWG 20; ohne Kunststoffkragen; galvanisch verzinkt | <a href="http://www.wago.com/216-122">www.wago.com/216-122</a> |
|------------------------------------------------------------------------------------|------------------------------------------------------------------------------------------------------------------------------|----------------------------------------------------------------|

|                                                                                    |                                                                                                                           |                                                                |
|------------------------------------------------------------------------------------|---------------------------------------------------------------------------------------------------------------------------|----------------------------------------------------------------|
|  | <b>Art-Nr.: 216-123</b><br>Aderendhülse; Hülse für 1 mm <sup>2</sup> / AWG 18; ohne Kunststoffkragen; galvanisch verzinkt | <a href="http://www.wago.com/216-123">www.wago.com/216-123</a> |
|------------------------------------------------------------------------------------|---------------------------------------------------------------------------------------------------------------------------|----------------------------------------------------------------|

|                                                                                    |                                                                                                                              |                                                                |
|------------------------------------------------------------------------------------|------------------------------------------------------------------------------------------------------------------------------|----------------------------------------------------------------|
|  | <b>Art-Nr.: 216-131</b><br>Aderendhülse; Hülse für 0,25 mm <sup>2</sup> / AWG 24; ohne Kunststoffkragen; galvanisch verzinkt | <a href="http://www.wago.com/216-131">www.wago.com/216-131</a> |
|------------------------------------------------------------------------------------|------------------------------------------------------------------------------------------------------------------------------|----------------------------------------------------------------|













|                                                                                    |                                                                                                                              |                                                                |
|------------------------------------------------------------------------------------|------------------------------------------------------------------------------------------------------------------------------|----------------------------------------------------------------|
|  | <b>Art-Nr.: 216-132</b><br>Aderendhülse; Hülse für 0,34 mm <sup>2</sup> / AWG 24; ohne Kunststoffkragen; galvanisch verzinkt | <a href="http://www.wago.com/216-132">www.wago.com/216-132</a> |
|------------------------------------------------------------------------------------|------------------------------------------------------------------------------------------------------------------------------|----------------------------------------------------------------|

|                                                                                    |                                                                                                                                                                                                    |                                                                |
|------------------------------------------------------------------------------------|----------------------------------------------------------------------------------------------------------------------------------------------------------------------------------------------------|----------------------------------------------------------------|
|  | <b>Art-Nr.: 216-141</b><br>Aderendhülse; Hülse für 0,5 mm <sup>2</sup> / AWG 22; ohne Kunststoffkragen; galvanisch verzinkt; Elektrolytkupfer; gasdicht aufgecrimpt; gemäß DIN 46228, Teil 1/08.92 | <a href="http://www.wago.com/216-141">www.wago.com/216-141</a> |
|------------------------------------------------------------------------------------|----------------------------------------------------------------------------------------------------------------------------------------------------------------------------------------------------|----------------------------------------------------------------|

|                                                                                    |                                                                                                                                                                                                     |                                                                |
|------------------------------------------------------------------------------------|-----------------------------------------------------------------------------------------------------------------------------------------------------------------------------------------------------|----------------------------------------------------------------|
|  | <b>Art-Nr.: 216-142</b><br>Aderendhülse; Hülse für 0,75 mm <sup>2</sup> / AWG 20; ohne Kunststoffkragen; galvanisch verzinkt; Elektrolytkupfer; gasdicht aufgecrimpt; gemäß DIN 46228, Teil 1/08.92 | <a href="http://www.wago.com/216-142">www.wago.com/216-142</a> |
|------------------------------------------------------------------------------------|-----------------------------------------------------------------------------------------------------------------------------------------------------------------------------------------------------|----------------------------------------------------------------|

|                                                                                    |                                                                                                                                                                                                  |                                                                |
|------------------------------------------------------------------------------------|--------------------------------------------------------------------------------------------------------------------------------------------------------------------------------------------------|----------------------------------------------------------------|
|  | <b>Art-Nr.: 216-143</b><br>Aderendhülse; Hülse für 1 mm <sup>2</sup> / AWG 18; ohne Kunststoffkragen; galvanisch verzinkt; Elektrolytkupfer; gasdicht aufgecrimpt; gemäß DIN 46228, Teil 1/08.92 | <a href="http://www.wago.com/216-143">www.wago.com/216-143</a> |
|------------------------------------------------------------------------------------|--------------------------------------------------------------------------------------------------------------------------------------------------------------------------------------------------|----------------------------------------------------------------|

**Art-Nr.: 216-151**

|                                                                                    |                                                                                                                                                                                                    |                                                                |
|------------------------------------------------------------------------------------|----------------------------------------------------------------------------------------------------------------------------------------------------------------------------------------------------|----------------------------------------------------------------|
|    | Aderendhülse; Hülse für 0,25 mm <sup>2</sup> / AWG 24; ohne Kunststoffkragen; galvanisch verzinkt                                                                                                  | <a href="http://www.wago.com/216-151">www.wago.com/216-151</a> |
|    | <b>Art-Nr.: 216-152</b><br>Aderendhülse; Hülse für 0,34 mm <sup>2</sup> / AWG 24; ohne Kunststoffkragen; galvanisch verzinkt                                                                       | <a href="http://www.wago.com/216-152">www.wago.com/216-152</a> |
|    | <b>Art-Nr.: 216-201</b><br>Aderendhülse; Hülse für 0,5 mm <sup>2</sup> / AWG 22; mit Kunststoffkragen; galvanisch verzinkt                                                                         | <a href="http://www.wago.com/216-201">www.wago.com/216-201</a> |
|    | <b>Art-Nr.: 216-202</b><br>Aderendhülse; Hülse für 0,75 mm <sup>2</sup> / AWG 20; mit Kunststoffkragen; galvanisch verzinkt                                                                        | <a href="http://www.wago.com/216-202">www.wago.com/216-202</a> |
|    | <b>Art-Nr.: 216-203</b><br>Aderendhülse; Hülse für 1 mm <sup>2</sup> / AWG 18; mit Kunststoffkragen; galvanisch verzinkt                                                                           | <a href="http://www.wago.com/216-203">www.wago.com/216-203</a> |
|    | <b>Art-Nr.: 216-221</b><br>Aderendhülse; Hülse für 0,5 mm <sup>2</sup> / AWG 22; mit Kunststoffkragen; galvanisch verzinkt                                                                         | <a href="http://www.wago.com/216-221">www.wago.com/216-221</a> |
|    | <b>Art-Nr.: 216-222</b><br>Aderendhülse; Hülse für 0,75 mm <sup>2</sup> / AWG 20; mit Kunststoffkragen; galvanisch verzinkt                                                                        | <a href="http://www.wago.com/216-222">www.wago.com/216-222</a> |
|    | <b>Art-Nr.: 216-223</b><br>Aderendhülse; Hülse für 1 mm <sup>2</sup> / AWG 18; mit Kunststoffkragen; galvanisch verzinkt                                                                           | <a href="http://www.wago.com/216-223">www.wago.com/216-223</a> |
|    | <b>Art-Nr.: 216-241</b><br>Aderendhülse; Hülse für 0,5 mm <sup>2</sup> / AWG 22; mit Kunststoffkragen; galvanisch verzinkt; Elektrolytkupfer; gasdicht aufgecrimpt; gemäß DIN 46228, Teil 4/09.90  | <a href="http://www.wago.com/216-241">www.wago.com/216-241</a> |
|   | <b>Art-Nr.: 216-242</b><br>Aderendhülse; Hülse für 0,75 mm <sup>2</sup> / AWG 20; mit Kunststoffkragen; galvanisch verzinkt; Elektrolytkupfer; gasdicht aufgecrimpt; gemäß DIN 46228, Teil 4/09.90 | <a href="http://www.wago.com/216-242">www.wago.com/216-242</a> |
|  | <b>Art-Nr.: 216-243</b><br>Aderendhülse; Hülse für 1 mm <sup>2</sup> / AWG 18; mit Kunststoffkragen; galvanisch verzinkt; Elektrolytkupfer; gasdicht aufgecrimpt; gemäß DIN 46228, Teil 4/09.90    | <a href="http://www.wago.com/216-243">www.wago.com/216-243</a> |
|  | <b>Art-Nr.: 216-262</b><br>Aderendhülse; Hülse für 0,75 mm <sup>2</sup> / AWG 20; mit Kunststoffkragen; galvanisch verzinkt; Elektrolytkupfer; gasdicht aufgecrimpt; gemäß DIN 46228, Teil 4/09.90 | <a href="http://www.wago.com/216-262">www.wago.com/216-262</a> |
|  | <b>Art-Nr.: 216-263</b><br>Aderendhülse; Hülse für 1 mm <sup>2</sup> / AWG 18; mit Kunststoffkragen; galvanisch verzinkt; Elektrolytkupfer; gasdicht aufgecrimpt; gemäß DIN 46228, Teil 4/09.90    | <a href="http://www.wago.com/216-263">www.wago.com/216-263</a> |
|  | <b>Art-Nr.: 216-301</b><br>Aderendhülse; Hülse für 0,25 mm <sup>2</sup> / AWG 24; mit Kunststoffkragen; galvanisch verzinkt                                                                        | <a href="http://www.wago.com/216-301">www.wago.com/216-301</a> |
|  | <b>Art-Nr.: 216-302</b><br>Aderendhülse; Hülse für 0,34 mm <sup>2</sup> / AWG 24; mit Kunststoffkragen; galvanisch verzinkt                                                                        | <a href="http://www.wago.com/216-302">www.wago.com/216-302</a> |
|  | <b>Art-Nr.: 216-321</b><br>Aderendhülse; Hülse für 0,25 mm <sup>2</sup> / AWG 24; mit Kunststoffkragen; galvanisch verzinkt                                                                        | <a href="http://www.wago.com/216-321">www.wago.com/216-321</a> |
|  | <b>Art-Nr.: 216-322</b><br>Aderendhülse; Hülse für 0,34 mm <sup>2</sup> / AWG 24; mit Kunststoffkragen; galvanisch verzinkt                                                                        | <a href="http://www.wago.com/216-322">www.wago.com/216-322</a> |

**Werkzeug**

|                                                                                    |                                                                                                       |                                                                |
|------------------------------------------------------------------------------------|-------------------------------------------------------------------------------------------------------|----------------------------------------------------------------|
|  | <b>Art-Nr.: 210-657</b><br>Betätigungswerkzeug mit teilisoliertem Schaft; Klinge (3,5 x 0,5) mm; kurz | <a href="http://www.wago.com/210-657">www.wago.com/210-657</a> |
|------------------------------------------------------------------------------------|-------------------------------------------------------------------------------------------------------|----------------------------------------------------------------|

**Art-Nr.: 210-720**



Betätigungswerkzeug mit teilisoliertem Schaft; Typ 2, Klinge (3,5 x 0,5) mm

[www.wago.com/210-720](http://www.wago.com/210-720)

## Downloads

### smartDATA

#### Leiterplatten Bibliotheken

|                                                                                                          |                      |                |          |
|----------------------------------------------------------------------------------------------------------|----------------------|----------------|----------|
| TARGET Bibliothek für WAGO-Leiterplattenklemmen<br>Kompatibel ab TARGET PCB Design Software Version 17.x | 1.1.0<br>Oct 6, 2014 | ZIP<br>27,1 MB | Download |
| EAGLE Bibliothek für WAGO-Leiterplattenklemmen<br>Kompatibel ab EAGLE PCB Design Software Version 6.x    | 2.1<br>Nov 17, 2017  | ZIP<br>23,9 MB | Download |
| DesignSpark Bibliothek für WAGO-Leiterplattenklemmen<br>Kompatibel ab DesignSpark PCB Version 4.x        | 2.1<br>Oct 6, 2014   | ZIP<br>22,5 MB | Download |

#### CAD Daten

|                             |     |          |
|-----------------------------|-----|----------|
| 3D Download 235-766/331-000 | URL | Download |
|-----------------------------|-----|----------|

Änderungen vorbehalten.

WAGO Kontakttechnik GmbH & Co. KG  
Hansastr. 27  
32423 Minden  
Telefon: +49571 887-0  
E-Mail: [info.de@wago.com](mailto:info.de@wago.com) | Web: [www.wago.com](http://www.wago.com)

Haben Sie Fragen zu unseren Produkten?  
Wir stehen Ihnen telefonisch unter +49 (571) 887-44222 gern zur  
Verfügung.