

»» Features

- Mini ISO high power automotive relay 30A/50A.
- High temperature endurance up to 125°C.
- Optional SPNC, SPNO, SPDT, DPNO contact configurations.
- Optional to be equipped with protection diode or resistor.
- Both available PCB terminal and quick connect terminal versions.
- Available for plain cover type, skirted cover flanged cover, and weather proof versions.
- Tinned terminal is available on request.
- Comply with RoHS-Directive 2002/95/EC, and ELV-Directive 2000/53/EC.
- Sockets on request.

»» Type List

Terminal style	Contact form	Enclosure style		
		Dust cover	Flux tight	Sealed type washable
Socket terminal	1A (SPNO)	896-1AH-D	896-1AH-C	896-1AH-S
		896H-1AH-D	896H-1AH-C	896H-1AH-S
	1C (SPDT)	896-1CH-D	896-1CH-C	896-1CH-S
		896H-1CH-D	896H-1CH-C	896H-1CH-S
	2A (DPNO)	896-2AH-D	896-2AH-C	896-2AH-S
		896H-2AH-D	896H-2AH-C	896H-2AH-S
PCB terminal	1A (SPNO)	896P-1AH-D	896P-1AH-C	896P-1AH-S
		896HP-1AH-D	896HP-1AH-C	896HP-1AH-S
	1C (SPDT)	896P-1CH-D	896P-1CH-C	896P-1CH-S
		896HP-1CH-D	896HP-1CH-C	896HP-1CH-S
	2A (DPNO)	896P-2AH-D	896P-2AH-C	896P-2AH-S
		896HP-2AH-D	896HP-2AH-C	896HP-2AH-S

Terminal style	Contact form	Enclosure style	
		Flanged cover (dust cover)	Flanged cover (flux tight)
Socket terminal	1A (SPNO)	896-1AH-D1	896-1AH-C1
		896H-1AH-D1	896H-1AH-C1
	1C (SPDT)	896-1CH-D1	896-1CH-C1
		896H-1CH-D1	896H-1CH-C1
	2A (DPNO)	896-2AH-D1	896-2AH-C1
		896H-2AH-D1	896H-2AH-C1



896

Terminal style	Contact form	Enclosure style	
		Steel bracket (dust cover)	Steel bracket (flux tight)
Socket terminal	1A (SPNO)	896-1AH-D1S	896-1AH-C1S
		896H-1AH-D1S	896H-1AH-C1S
	1C (SPDT)	896-1CH-D1S	896-1CH-C1S
		896H-1CH-D1S	896H-1CH-C1S
	2A (DPNO)	896-2AH-D1S	896-2AH-C1S
		896H-2AH-D1S	896H-2AH-C1S

Terminal style	Contact form	Designation (provided with)	Enclosure style	
			Steel bracket (dust cover with shroud)	Steel bracket (dust cover with weather proof)
Socket terminal	1C (SPDT)	Resistor	896H-1CH-D1SF-R1	896H-1CH-D1SW-R1

»» Ordering Information

896 H P - 1CH - C - R1 - T 001
 1 2 3 4 5 6 7 8

- | | | | | | |
|----|-------|--|------|--|---|
| 1. | 896 | -- Basic series designation | D1S | -- Steel bracket (dust cover) | |
| | | | C1S | -- Steel bracket (flux tight) | |
| 2. | Blank | -- Standard type | S1S | -- Steel bracket (sealed type washable) | |
| | H | -- High power type | D1SF | -- Steel bracket (dust cover with shroud) | |
| 3. | Blank | -- Socket terminal | D1SW | -- Steel bracket (dust cover with weather proof) | |
| | P | -- PCB terminal | | | |
| 4. | 1AH | -- Single pole normally open, contact material AgSnO | 6. | Blank | -- Standard type |
| | 1BH | -- Single pole normally closed, contact material AgSnO | | R1 | -- Coil parallel with resistor 1/2W for 12V 68Ω , 24V 270Ω |
| | 1CH | -- Single pole double throw, contact material AgSnO | 7. | Blank | -- Standard type |
| | 2AH | -- Double pole double make, contact material AgSnO | | T | -- Special requirement for Tin plated terminal |
| 5. | D | -- Dust cover | 8. | Blank | -- Standard type |
| | C | -- Flux tight | | 001 | -- Coil parallel with diode IN4007 the positive pole on # 85 terminal |
| | S | -- Sealed type washable | | 002 | -- Coil parallel with diode IN4007 the negative pole on # 85 terminal |
| | C1 | -- Flanged cover (flux tight) | | | |
| | D1 | -- Flanged cover (dust cover) | | | |
| | S1 | -- Flanged cover (sealed type washable) | | | |

»» Contact Rating

Type	896 1A	896 1B	896 1C	896 2A
Resistive load	40A 14VDC	40A 14VDC	NO : 40A 14VDC NC : 30A 14VDC	2×15A 14VDC

Type	896H 1A	896H 1B	896H 1C	896H 2A
Resistive load	50A 14VDC 20A 28VDC	40A 14VDC 15A 28VDC	NO : 50A 14VDC, 20A 28VDC NC : 30A 14VDC, 15A 28VDC	2×30A 14VDC 2×10A 28VDC

»» Coil Rating(DC)

Rated voltage (V)	Rated current ±10 % at 23°C (mA)	Coil resistance ±10 % at 23°C (Ω)	Max. continuous Voltage at 85°C ⁽¹⁾	Pick up voltage(Max) at 23°C	Drop out voltage(Min) at 23°C	Power consumption at rated voltage
12	133	90	120% of rated voltage	65% of rated voltage	10% of rated voltage	approx. 1.6W
24	66.7	360				

Notes : (1) Without switching the load.

»» Specification

Contact material	AgSnO alloy	
Contact voltage drop ⁽¹⁾	Typ. 50mV at 10A	
Insulation resistance ⁽¹⁾	20MΩ Min. (DC 500V)	
Operate time ⁽¹⁾	20ms Max.	
Release time ⁽¹⁾	20ms Max.	
Dielectric strength ⁽¹⁾	Between open contact	: AC 500V , 50/60Hz 1 min.
	Between contact and coil	: AC 500V , 50/60Hz 1 min.
Vibration resistance	Operating extremes	10~55Hz , amplitude 2mm
	Shock resistance	
Life expectancy	Mechanical	10,000,000 operations (frequency 18,000 operations/hr)
	Electrical	100,000 operations (frequency 1,200 operations/hr)
Temperature range	Operating	-40~+125°C (no freezing)
Weight	Approx. 40 g	

Note : (1) initial value



896

»» Outline Dimensions

◆ 896,896H (C,D,S)

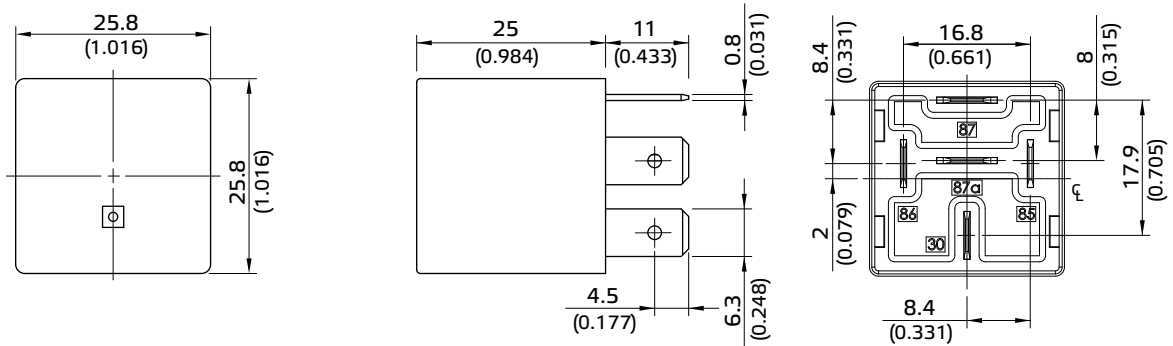

◆ 896,896H (C1,D1,S1)

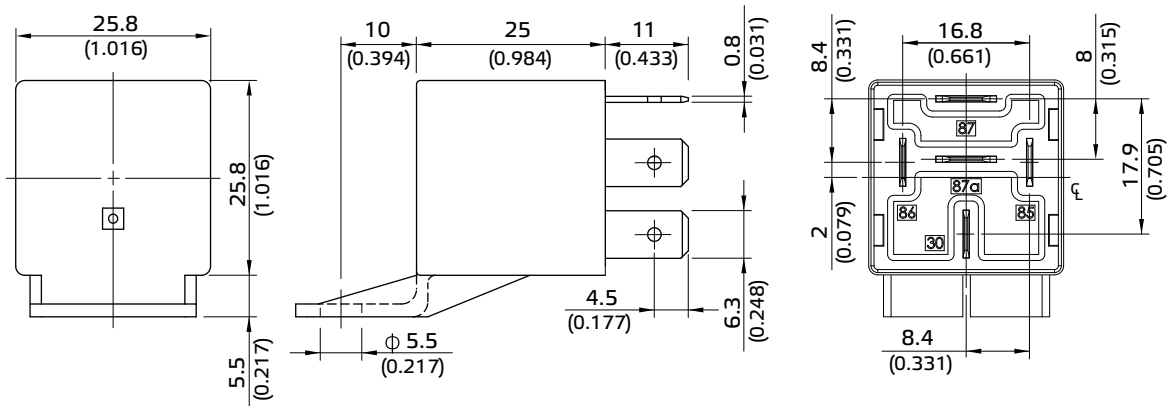

◆ 896,896H (C1S,D1S,S1S)

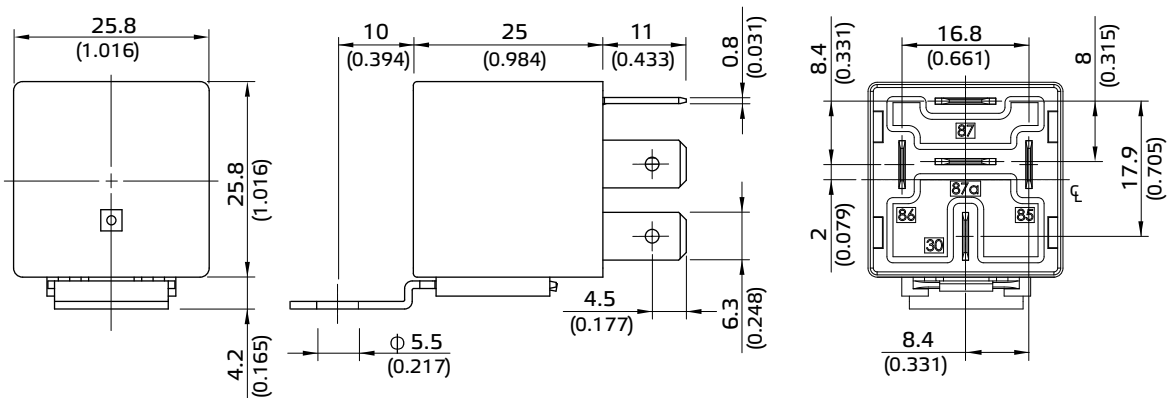

◆ 896P,896HP (C,D,S)

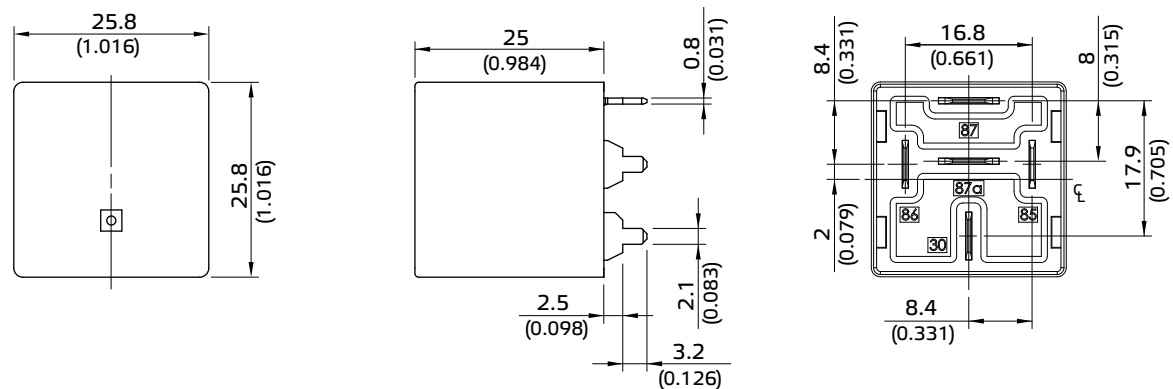

◆896H (D1SW)

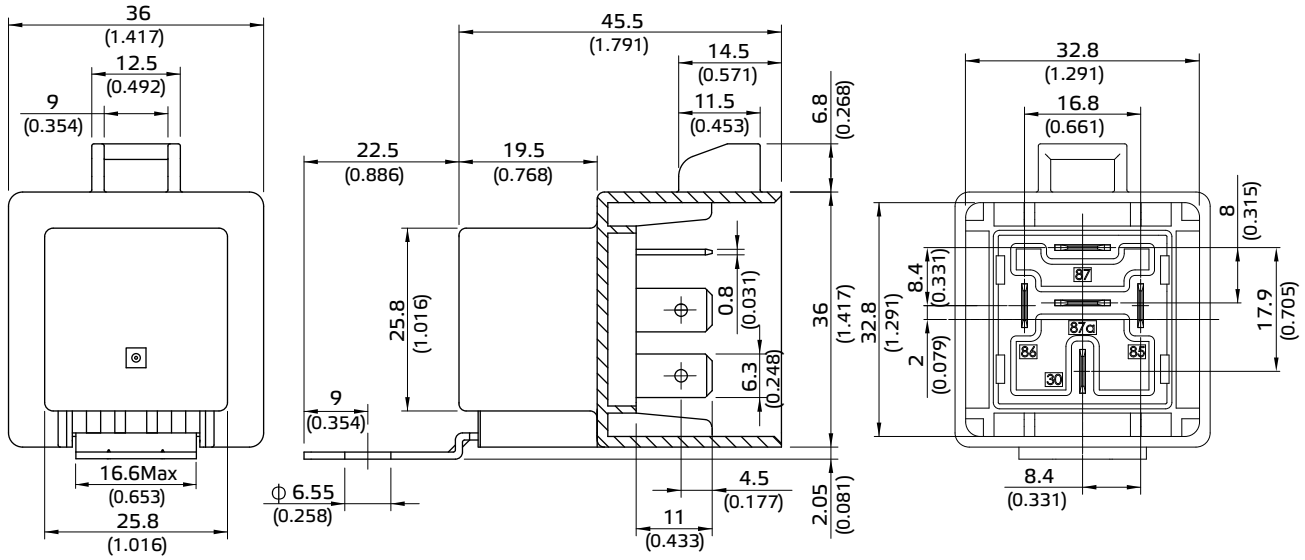

◆896H (D1SF)

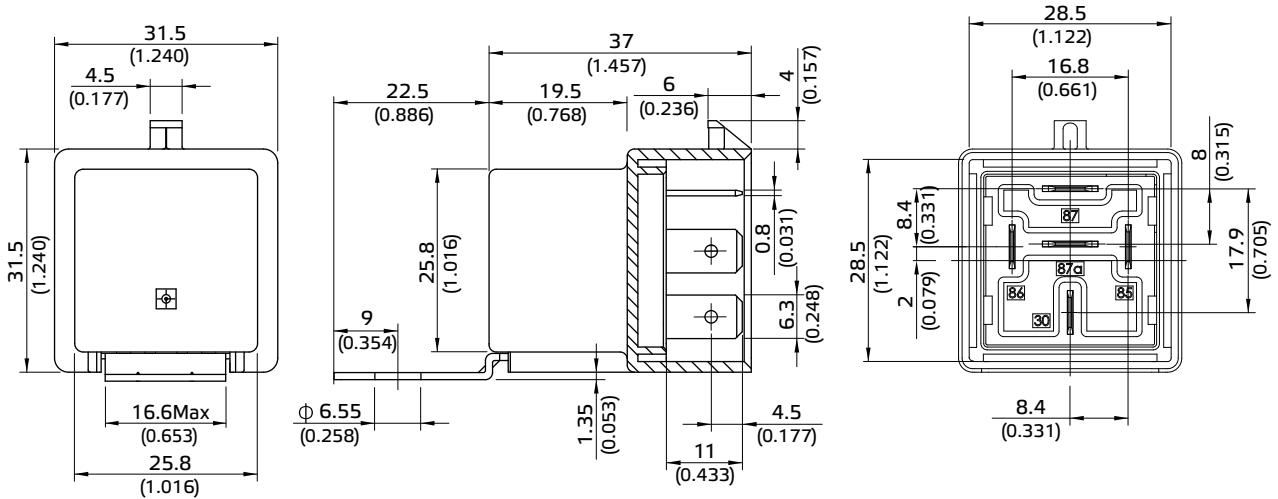



896

»» Wiring Diagram

BOTTOM VIEW

1A

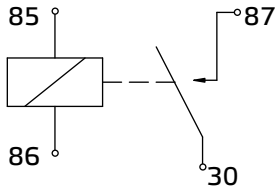

1B

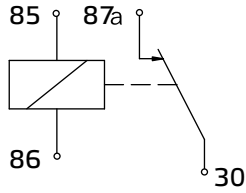

1C

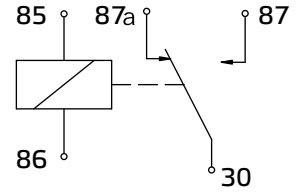

2A

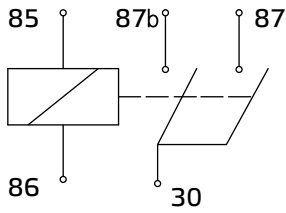

R1

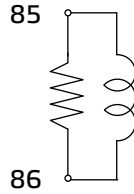

001

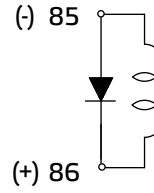

002

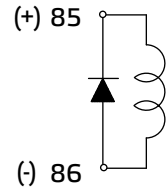

»» PC Board Layout

BOTTOM VIEW

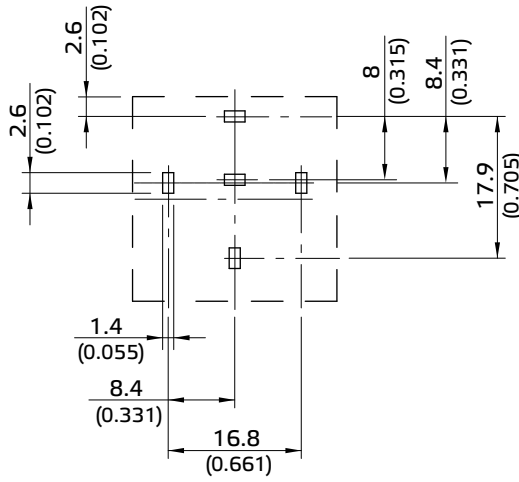

»» Engineering Data

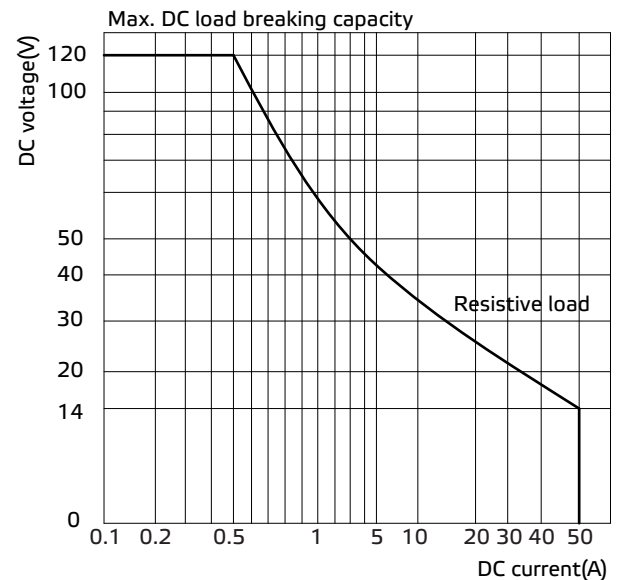
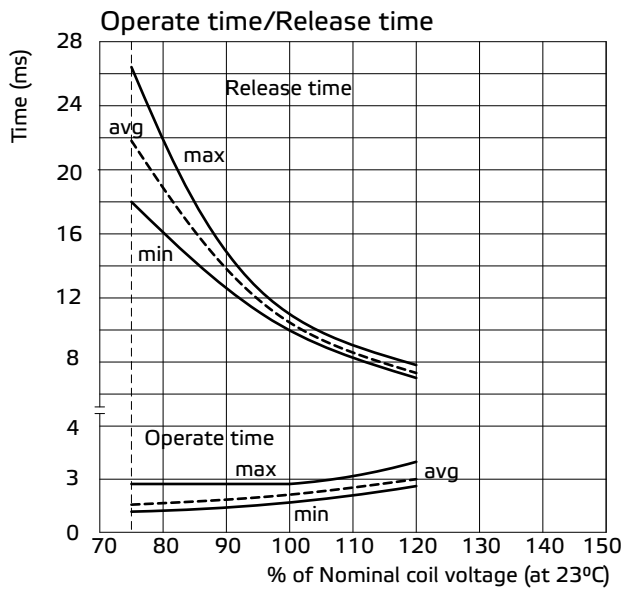
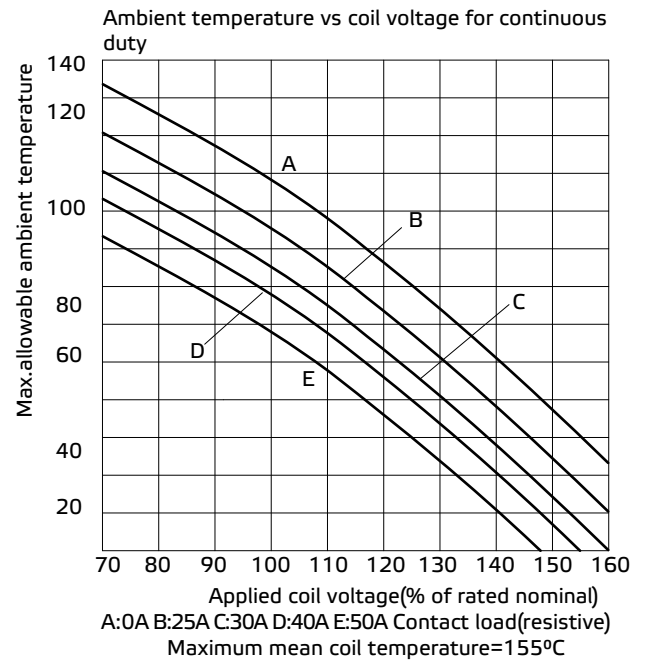
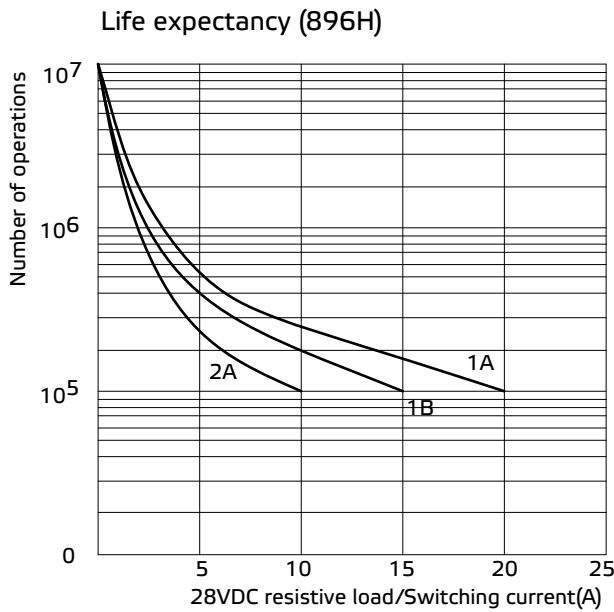
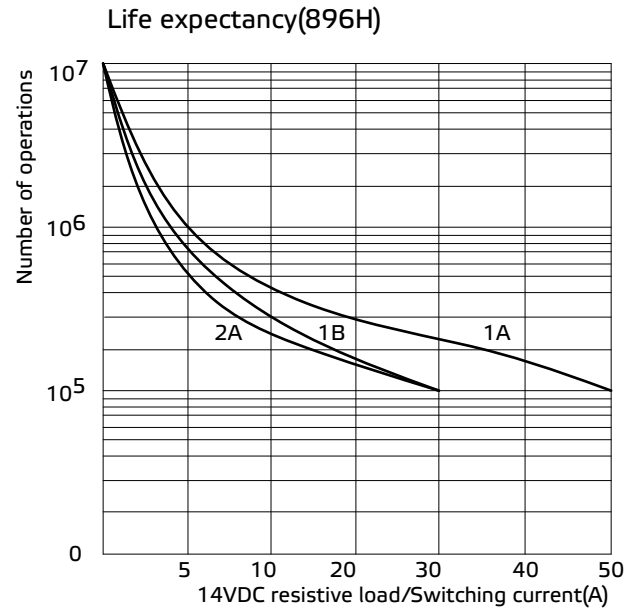
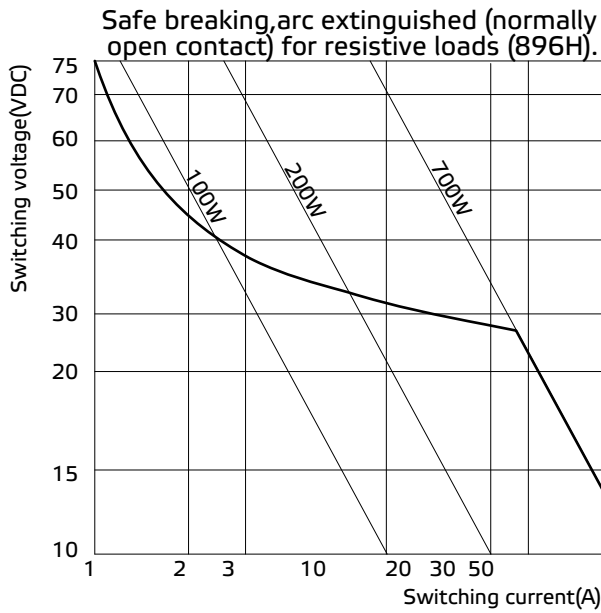

SERIES NO. 896H

Series No. 896H

Features:

- Contact Rating 50A
- High Temperature Version
- 4 Different Contact Arrangements
- Standardized Design for Plug-in Quick Connect Terminals and PCB
- Optional Mounting Bracket

Drawing/Terminal layout:

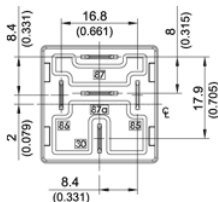

Relay photograph:



DESCRIPTION	DETAILS	DESCRIPTION	DETAILS
Size(LxWxH) not including terminals	25.8x25.8x25	Contact Configuration	1 FORM C TO 2 FORM A
Max.Allowable Contact current	50A	Contact Rating Resistive load	50A/14VDC
Insulation System	None	Coil Voltage	DC: 12-24VDC
Coil Operating Power at nominal voltage	DC: 1.6W	Expected mechanical life (min.)	1x10 ⁴
Expected electrical life (min.)	1x10 ⁵	Terminal type	Auto Relays
Dielectric Strength AC Voltage- 1 minute			
Between open contact	500V	Between contact and coil	500V
Between contact circuits			

DATASHEET



1633

[896H.pdf](#) Kb