

# Data sheet | Item number: 789-127

PCB terminal block; 2.5 mm<sup>2</sup>; Pin spacing 5 mm; 3-pole; CAGE CLAMP®

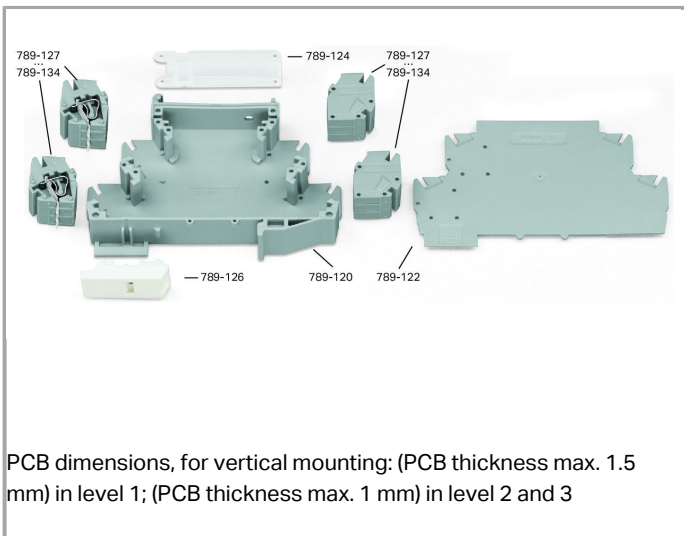

[www.wago.com/789-127](http://www.wago.com/789-127)

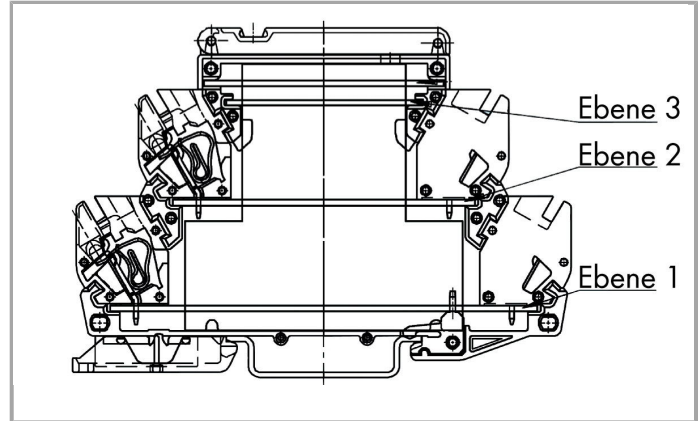
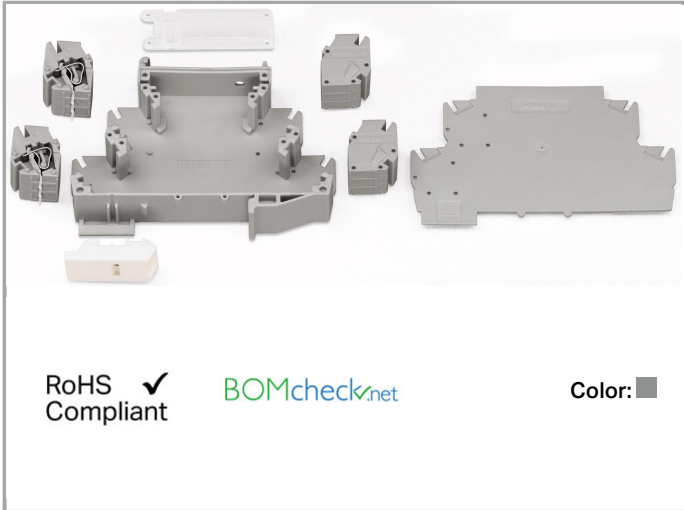

## Item description

Universal modular component housing, as DIN-rail-mount enclosure – terminal block, 3-pole: CCC\*

(\*C = with clamping spring; O = without clamping spring; enclosure open on the right side)

## Data

### Connection data

No. of poles	3
Connections (number)	3

## Mechanical data

Housing design	DIN-rail-mount enclosure
Geeignet für	For 789-120

## Material Data





Color	gray
Fire load	0.072 MJ
Weight	4.275 g

## Commercial data

Country of origin	DE
GTIN	4044918610537
Customs Tariff No.	85369010000

## Compatible products

### ferrule

	<b>Item no.: 216-241</b> Ferrule; Sleeve for 0.5 mm <sup>2</sup> / AWG 22; insulated; electro-tin plated; electrolytic copper; gastight crimped; acc. to DIN 46228, Part 4/09.90	<a href="http://www.wago.com/216-241">www.wago.com/216-241</a>
	<b>Item no.: 216-242</b> Ferrule; Sleeve for 0.75 mm <sup>2</sup> / AWG 20; insulated; electro-tin plated; electrolytic copper; gastight crimped; acc. to DIN 46228, Part 4/09.90	<a href="http://www.wago.com/216-242">www.wago.com/216-242</a>
	<b>Item no.: 216-243</b> Ferrule; Sleeve for 1 mm <sup>2</sup> / AWG 18; insulated; electro-tin plated; electrolytic copper; gastight crimped; acc. to DIN 46228, Part 4/09.90	<a href="http://www.wago.com/216-243">www.wago.com/216-243</a>
	<b>Item no.: 216-244</b> Ferrule; Sleeve for 1.5 mm <sup>2</sup> / AWG 16; insulated; electro-tin plated; electrolytic copper; gastight crimped; acc. to DIN 46228, Part 4/09.90	<a href="http://www.wago.com/216-244">www.wago.com/216-244</a>

## Downloads

### Documentation

#### Additional Information

Disposal; Electrical and electronic equipment, Packaging	Oct 15, 2018	Download
		265.8 kB

## smartDATA

### CAD data

3D Download 789-127	URL	Download
---------------------	-----	----------



Subject to changes.

---

WAGO Kontakttechnik GmbH & Co. KG  
Hansastr. 27  
32423 Minden  
Phone: +49571 887-0 | Fax: +49571 887-169  
Email: [info.de@wago.com](mailto:info.de@wago.com) | Web: [www.wago.com](http://www.wago.com)

Do you have any questions about our products?  
We are always happy to take your call at +49 (571) 887-44222.