

# Base strip - MSTBA 2,5/ 5-G - 1757501

Please be informed that the data shown in this PDF Document is generated from our Online Catalog. Please find the complete data in the user's documentation. Our General Terms of Use for Downloads are valid (<http://download.phoenixcontact.com>)



Header, Nominal current: 12 A, Rated voltage (III/2): 320 V, Number of positions: 5, Pitch: 5 mm, Color: green, Contact surface: Tin, Assembly: Soldering

The figure shows a 10-position version of the product

## Product Features

- Other pin lengths available on request
- Plug-in direction parallel to the conductor axis
- W type with stand-off
- Standard pin strip for 320 V (III/2)

## Key commercial data

package_quantity	250
GTIN	4017918030032

## Technical data

### Dimensions

Length	12 mm
Pitch	5 mm
Dimension a	20 mm
Pin dimensions	1 x 1 mm
Hole diameter	1.4 mm

### General

Range of articles	MSTBA 2,5/...-G
Insulating material group	I
Rated surge voltage (III/3)	4 kV
Rated surge voltage (III/2)	4 kV
Rated surge voltage (II/2)	4 kV
Rated voltage (III/3)	250 V
Rated voltage (III/2)	320 V
Rated voltage (II/2)	400 V
Connection in acc. with standard	EN-VDE
Nominal current I <sub>N</sub>	12 A
Maximum load current	12 A
Insulating material	PA

# Base strip - MSTBA 2,5/ 5-G - 1757501

## Technical data

### General

<b>Inflammability class according to UL 94</b>	V0
<b>Color</b>	green
<b>Number of positions</b>	5

## classifications

### eCl@ss

<b>eCl@ss 4.0</b>	272607xx
<b>eCl@ss 4.1</b>	27260701
<b>eCl@ss 5.0</b>	27260701
<b>eCl@ss 5.1</b>	27260701
<b>eCl@ss 6.0</b>	27260704
<b>eCl@ss 7.0</b>	27440402
<b>eCl@ss 8.0</b>	27440402

### ETIM

<b>ETIM 3.0</b>	EC001121
<b>ETIM 4.0</b>	EC002637
<b>ETIM 5.0</b>	EC002637

### UNSPSC

<b>UNSPSC 6.01</b>	30211810
<b>UNSPSC 7.0901</b>	39121409
<b>UNSPSC 11</b>	39121409
<b>UNSPSC 12.01</b>	39121409
<b>UNSPSC 13.2</b>	39121409

## approvals

CSA / UL Recognized / VDE Gutachten mit Fertigungsüberwachung / cUL Recognized / GOST / IECCE CB Scheme / GOST / CSA / CCA / cULus Recognized /

### Approval details

		
<b>Usegroups</b>	<b>B</b>	<b>D</b>
Nominal voltage UN	300 V	300 V
Nominal current IN	15 A	10 A
mm <sup>2</sup> /AWG/kcmil		

# Base strip - MSTBA 2,5/ 5-G - 1757501

## approvals

**UL Recognized**

Usegroups	B	D
Nominal voltage UN	300 V	300 V
Nominal current IN	15 A	10 A
mm <sup>2</sup> /AWG/kcmil		

**VDE Gutachten mit Fertigungsüberwachung**

Nominal voltage UN	250 V
Nominal current IN	12 A
mm <sup>2</sup> /AWG/kcmil	

**cUL Recognized**

Usegroups	B	D
Nominal voltage UN	300 V	300 V
Nominal current IN	15 A	10 A
mm <sup>2</sup> /AWG/kcmil		

**GOST**

**IECEE CB Scheme**

Nominal voltage UN	250 V
Nominal current IN	12 A
mm <sup>2</sup> /AWG/kcmil	

# Base strip - MSTBA 2,5/ 5-G - 1757501

## approvals

Usegroups	B	D
Nominal voltage UN	300 V	300 V
Nominal current IN	10 A	10 A
mm <sup>2</sup> /AWG/kcmil		

CCA	
Nominal voltage UN	250 V
Nominal current IN	12 A
mm <sup>2</sup> /AWG/kcmil	

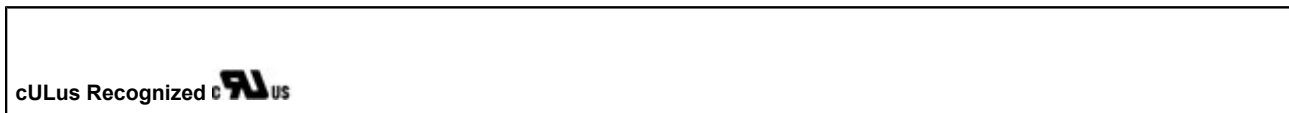

## accessories

### Filler plug

MSTB-BL - 1755477



### Labeled terminal marker

SK 5/3,8:FORTL.ZAHLEN - 0804183



### Coding element

CR-MSTB - 1734401



# Base strip - MSTBA 2,5/ 5-G - 1757501

## Drawings

### Drilling diagram

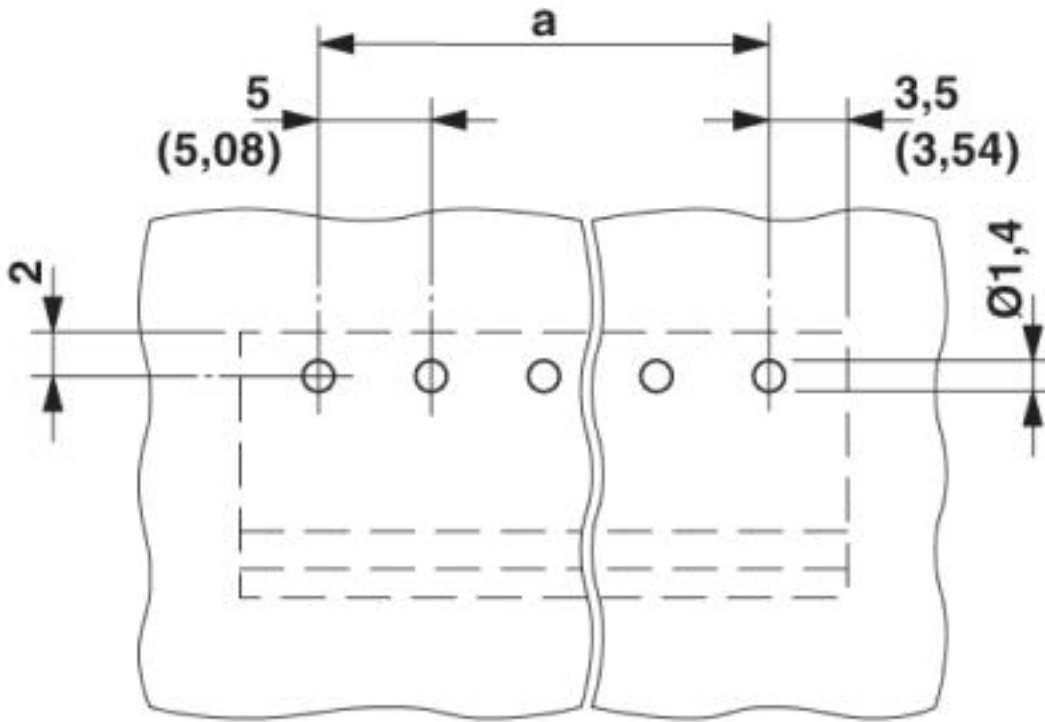

# Base strip - MSTBA 2,5/ 5-G - 1757501

Diagram

Plug: TMSTBP 2,5/5-ST(F)-(-5,08)  
Header: MSTB(A) 2,5/5-G(F)-(-5,08)

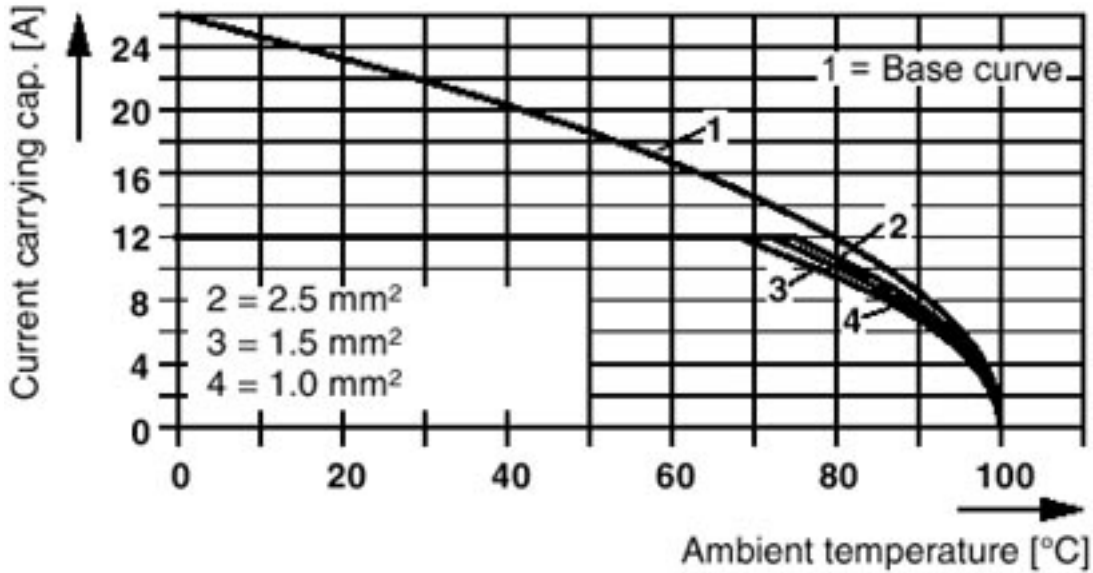

Diagram

Plug: MSTB 2,5/5-ST(F)-(-5,08)  
Header: MSTBO 2,5/5-GR(L)-(-5,08)

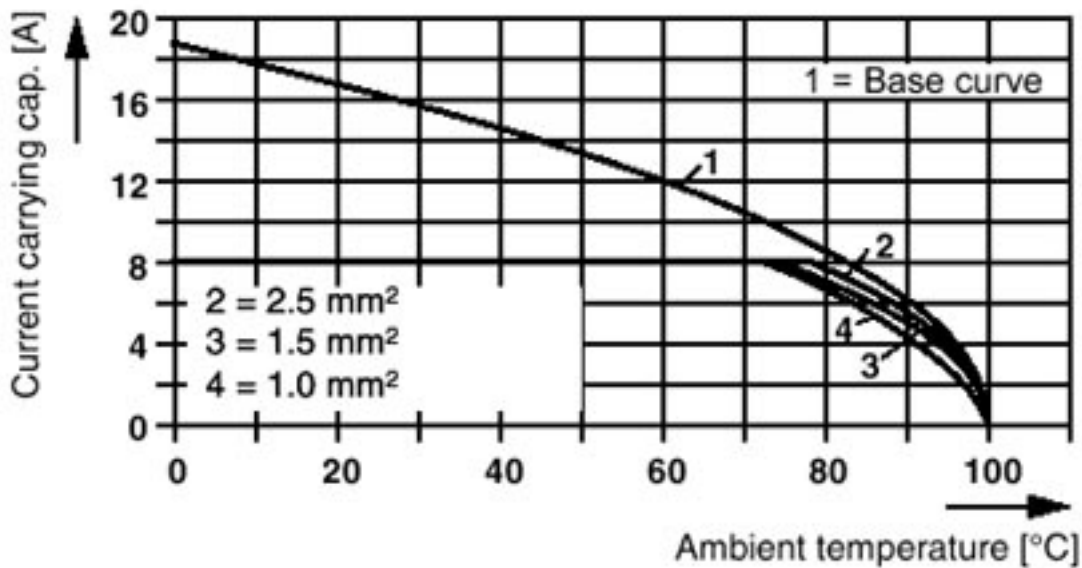

# Base strip - MSTBA 2,5/ 5-G - 1757501

Diagram

Plug: MSTBT 2,5/5-ST(F)-(-5,08)  
Header: MSTB(A) 2,5/5-G(F)-(-5,08)

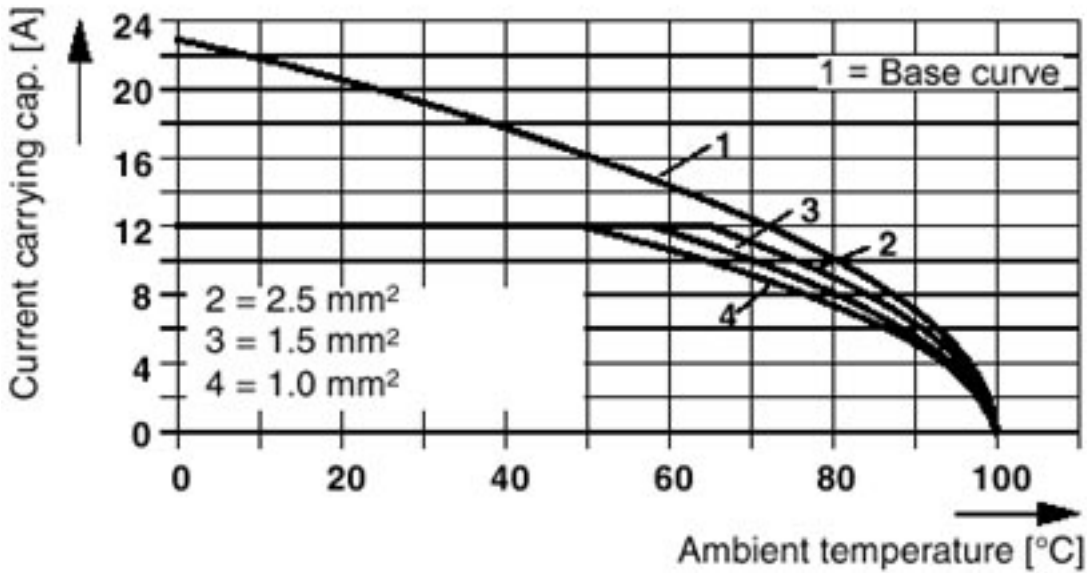

Diagram

Plug: SMSTB 2,5/5-ST(F)-(-5,08)  
Header: MSTB(A) 2,5/5-G(F)-(-5,08)

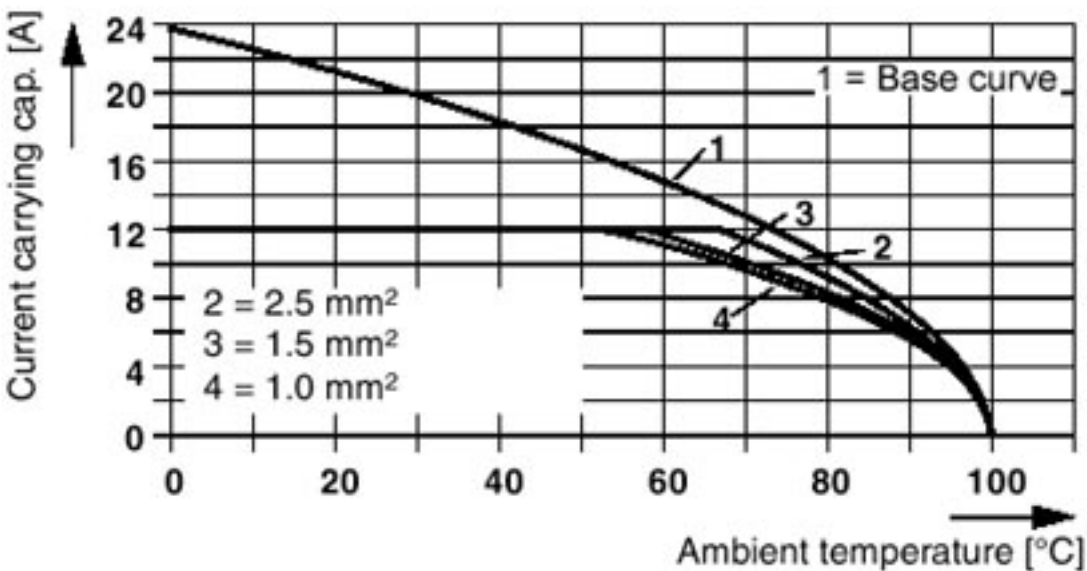

# Base strip - MSTBA 2,5/ 5-G - 1757501

Diagram

Plug: MVSTBR(W) 2,5/5-ST(F)-(-5,08)  
Header: MSTB(A) 2,5/5-G(F)-(-5,08)

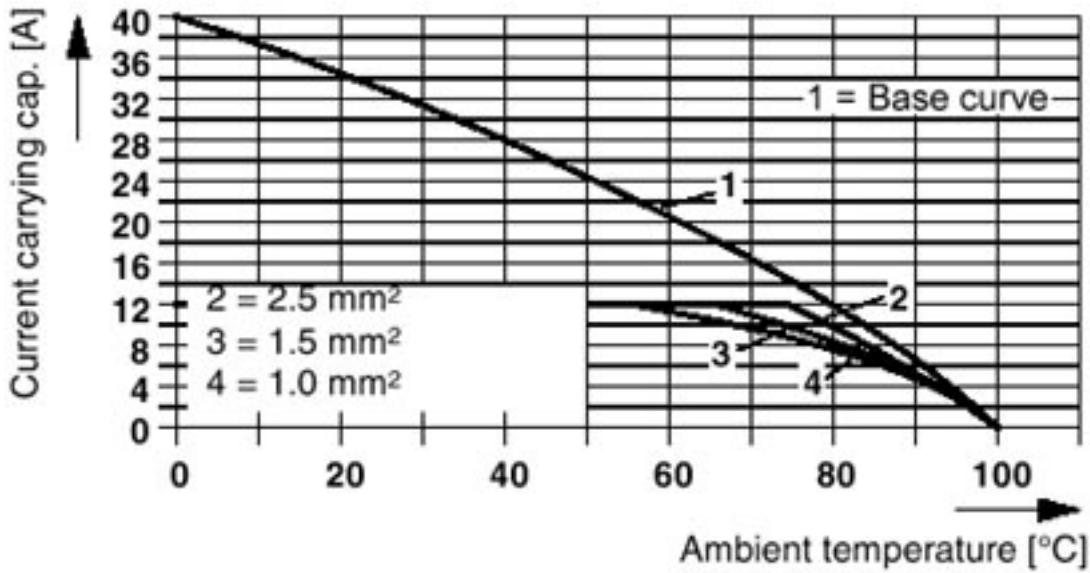

Diagram

Plug: FRONT-MSTB 2,5/5-ST(F)-(-5,08)  
Header: MSTB(A) 2,5/5-G(F)-(-5,08)

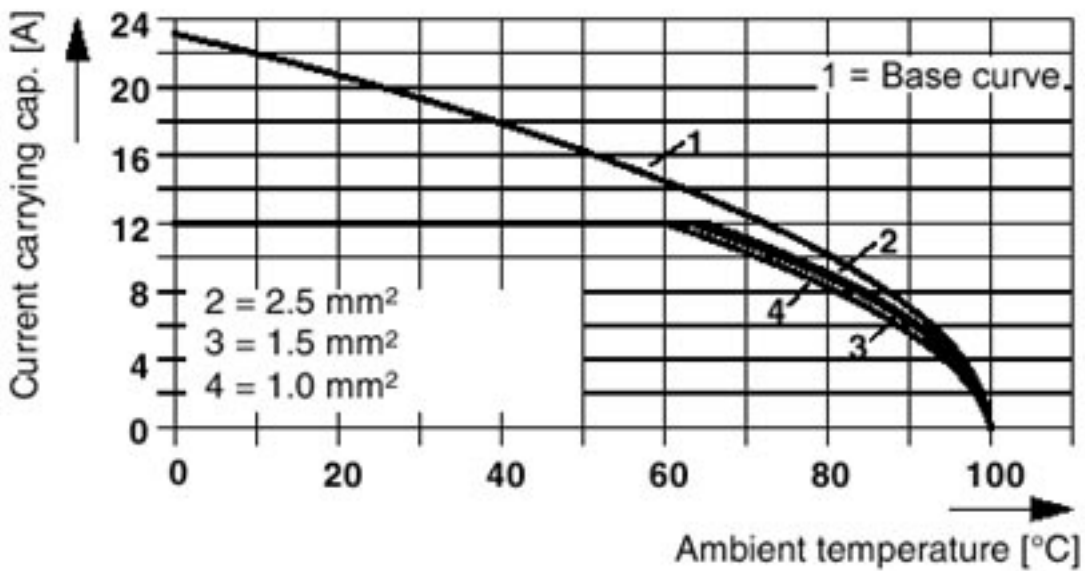



# Base strip - MSTBA 2,5/ 5-G - 1757501

Diagram

Type: FKCVR 2,5/...-ST with MSTBA 2,5/...-G

Dimensioned drawing

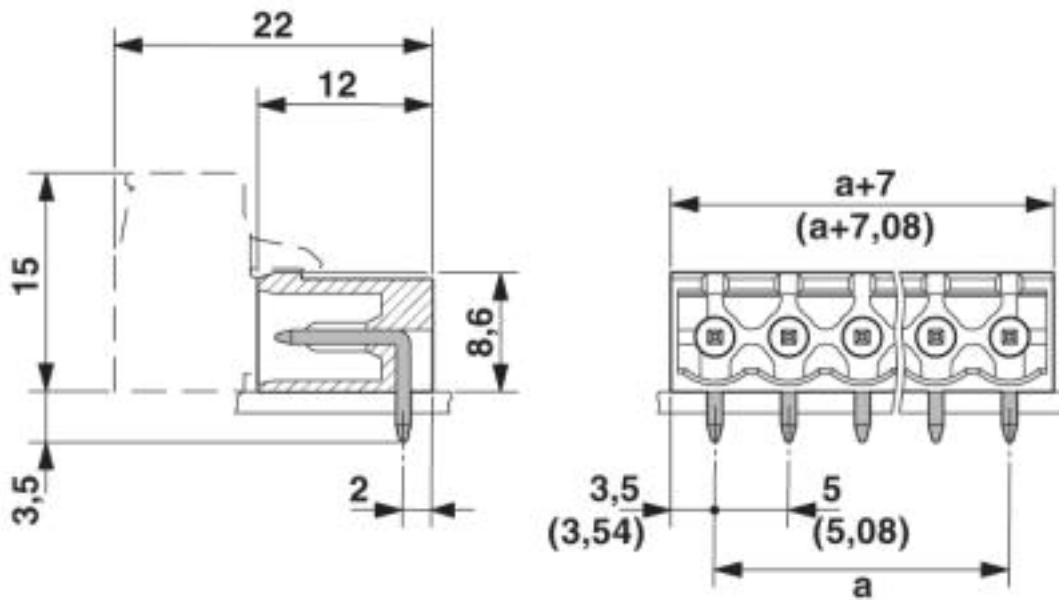

© Phoenix Contact 2013 - all rights reserved  
<http://www.phoenixcontact.com>