

## Data sheet | Item number: 862-2515

4-conductor chassis-mount terminal strip; Snap-in feet at pos. 1+3+5; L3-N-PE-L1-L2; without ground contact; 5-pole



[www.wago.com/862-2515](http://www.wago.com/862-2515)



RoHS Compliant

[BOMcheck.net](https://www.bomcheck.net)

Color:

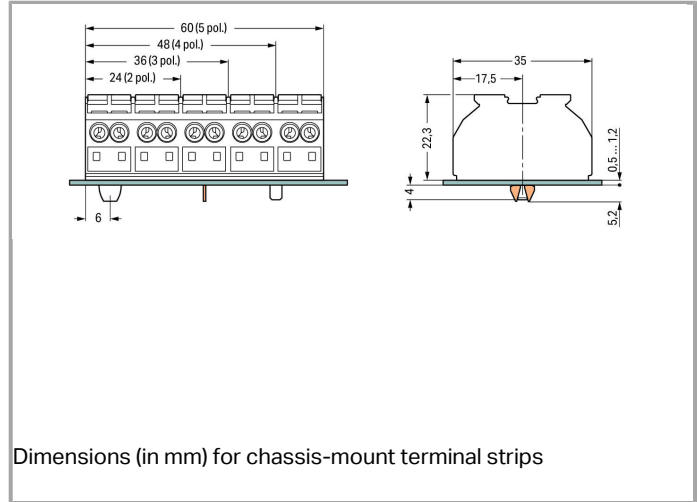

### Data

#### Electrical data

#### Ratings per IEC/EN 60664-1

Rated voltage (III / 3)	500 V
Rated impulse voltage (III / 3)	6 kV
Rated current	32 A
Legend (ratings)	(III / 3) ≙ Overvoltage category III / Pollution degree 3

#### Connection data

Connection technology	Push-in CAGE CLAMP®
Actuation type	Operating tool Push-button
Connectable conductor materials	Copper Aluminum
Solid conductor	0.5 ... 4 mm <sup>2</sup> / 20 ... 12 AWG
Solid conductor, push-in termination	0.75 ... 4 mm <sup>2</sup> / 18 ... 12 AWG
Stranded conductor	0.5 ... 4 mm <sup>2</sup> / 20 ... 12 AWG



Fine-stranded conductor	0.5 ... 4 mm <sup>2</sup> / 20 ... 12 AWG
Fine-stranded conductor with ferrule with plastic collar	0.5 ... 2.5 mm <sup>2</sup> / 20 ... 12 AWG
Fine-stranded conductor with ferrule, push-in termination, from	0.75 mm <sup>2</sup> / 18 AWG
Strip length	10 ... 11 mm / 0.39 ... 0.43 Inch
No. of poles	5
Total number of connection points	20
Total number of potentials	5
Type of wiring	Side-entry wiring

### Geometrical Data

Pin spacing	12 mm / 0.472 inch
Width	60 mm / 2.362 inch
Height from the surface	22.3 mm / 0.878 inch
Depth	35 mm / 1.378 inch

### Mechanical data

Mounting type	Snap-in mounting foot
Marking	L3-N-PE-L1-L2

### Material Data

Color	black
Fire load	0.646 MJ
Weight	34.854 g

### Commercial data

Packaging type	bag
Country of origin	DE
GTIN	4044918509978
Customs Tariff No.	85369010000
Product Group	9 (Std. Chassis Mt. Blocks)

### Approvals / Certificates

#### Country specific Approvals

Logo	Approval	Certificate name
	CCA DEKRA Certification B.V.	NTR NL 6912
	CCA DEKRA Certification B.V.	2146425.01



CSA  
DEKRA Certification B.V.

1505030



ENEC 15  
UL International Germany GmbH

143856-01

#### Ship Approvals







Logo	Approval	Certificate name
	LR Lloyds Register	91/20112 (E9)

#### UL-Approvals

Logo	Approval	Certificate name
	UL UL International Germany GmbH	E45172 sec. 39

#### Compatible products

##### ferrule

	<p><b>Item no.: 216-141</b> Ferrule; Sleeve for 0.5 mm<sup>2</sup> / AWG 22; uninsulated; electro-tin plated; electrolytic copper; gastight crimped; acc. to DIN 46228, Part 1/08.92</p>	<a href="http://www.wago.com/216-141">www.wago.com/216-141</a>
	<p><b>Item no.: 216-142</b> Ferrule; Sleeve for 0.75 mm<sup>2</sup> / AWG 20; uninsulated; electro-tin plated; electrolytic copper; gastight crimped; acc. to DIN 46228, Part 1/08.92</p>	<a href="http://www.wago.com/216-142">www.wago.com/216-142</a>
	<p><b>Item no.: 216-143</b> Ferrule; Sleeve for 1 mm<sup>2</sup> / AWG 18; uninsulated; electro-tin plated; electrolytic copper; gastight crimped; acc. to DIN 46228, Part 1/08.92</p>	<a href="http://www.wago.com/216-143">www.wago.com/216-143</a>
	<p><b>Item no.: 216-144</b> Ferrule; Sleeve for 1.5 mm<sup>2</sup> / AWG 16; uninsulated; electro-tin plated; electrolytic copper; gastight crimped; acc. to DIN 46228, Part 1/08.92</p>	<a href="http://www.wago.com/216-144">www.wago.com/216-144</a>
	<p><b>Item no.: 216-241</b> Ferrule; Sleeve for 0.5 mm<sup>2</sup> / AWG 22; insulated; electro-tin plated; electrolytic copper; gastight crimped; acc. to DIN 46228, Part 4/09.90</p>	<a href="http://www.wago.com/216-241">www.wago.com/216-241</a>
	<p><b>Item no.: 216-242</b> Ferrule; Sleeve for 0.75 mm<sup>2</sup> / AWG 20; insulated; electro-tin plated; electrolytic copper; gastight crimped; acc. to DIN 46228, Part 4/09.90</p>	<a href="http://www.wago.com/216-242">www.wago.com/216-242</a>
	<b>Item no.: 216-243</b>	



Ferrule; Sleeve for 1 mm<sup>2</sup> / AWG 18; insulated; electro-tin plated; electrolytic copper; gastight crimped; [www.wago.com/216-243](http://www.wago.com/216-243)  
acc. to DIN 46228, Part 4/09.90



**Item no.: 216-244**  
Ferrule; Sleeve for 1.5 mm<sup>2</sup> / AWG 16; insulated; electro-tin plated; electrolytic copper; gastight crimped; acc. to DIN 46228, Part 4/09.90 [www.wago.com/216-244](http://www.wago.com/216-244)

check



**Item no.: 210-136**  
Test plug; 2 mm Ø; with 500 mm cable [www.wago.com/210-136](http://www.wago.com/210-136)



**Item no.: 210-137**  
Test plug; 2.3 mm Ø; with 500 mm cable [www.wago.com/210-137](http://www.wago.com/210-137)

tools



**Item no.: 210-720**  
Operating tool with partially insulated shaft; Type 2, blade (3.5 x 0.5) mm [www.wago.com/210-720](http://www.wago.com/210-720)

Marking accessories



**Item no.: 709-177**  
Marking strips; on reel; 7.5 mm wide; not stretchable; plain; snap-on type [www.wago.com/709-177](http://www.wago.com/709-177)



**Item no.: 709-178**  
Marking strips; on reel; 7.5 mm wide; not stretchable; plain; snap-on type [www.wago.com/709-178](http://www.wago.com/709-178)

Jumper



**Item no.: 862-482**  
Comb-style jumper bar; for conductor entry; insulated; terminated conductor entry [www.wago.com/862-482](http://www.wago.com/862-482)

Downloads

Documentation

Bid Text

862-2515	Oct 19, 2017	DOC 25.1 kB	Download
----------	--------------	----------------	----------

smartDATA

CAD data

3D Download 862-2515	URL	Download
----------------------	-----	----------



Subject to changes.

---

WAGO Kontakttechnik GmbH & Co. KG  
Hansastr. 27  
32423 Minden  
Phone: +49571 887-0 | Fax: +49571 887-169  
Email: [info.de@wago.com](mailto:info.de@wago.com) | Web: [www.wago.com](http://www.wago.com)

Do you have any questions about our products?  
We are always happy to take your call at +49 (571) 887-44222.