

SERIES 1683 - SINGLE AND DOUBLE-POLE PUSHBUTTON SWITCHES

TO 16 A 250 V AC

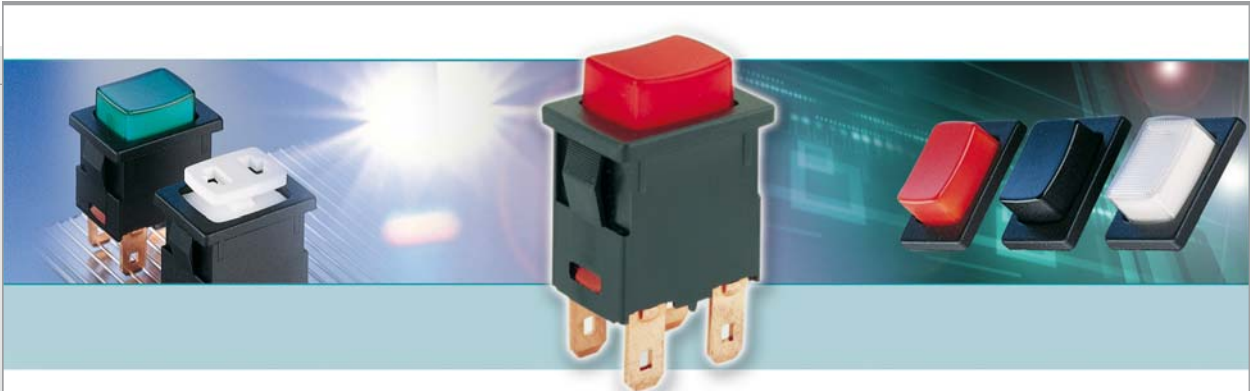



PRODUCT FEATURES

- ◆ Million times proven, double lifting contact system
- ◆ High electrical rating up to 16 A
- ◆ High rating with 100 000 mechanical switching cycles
- ◆ Illuminated and non-illuminated variants

ON REQUEST





































- ◆ Other colors
- ◆ Printing
- ◆ Other lamp variants
- ◆ Snap-on customized actuators
- ◆ Other connection variants (e.g. 6.3 x 0.8 mm)
- ◆ Cable assembly
- ◆ Variant with dust and water protection

| | |
|--|---|
| Mechanical life endurance | 10E4 |
| Operating force | ca. 12 N ca. 8 N (basic type 1683) |
| Contact resistance (new condition) | < 100 mOhm (1 A 12 V DC) |
| Insulation resistance (new condition) | > 100 MOhm (500 V DC) |
| Voltage strength at 250 V | 1 500 V function insulation / basic insulation 3 000 V reinforced insulation 500 V small contact distance |
| Proof tracking | 250 PTI |
| Insulation spacing | acc. to EN 61058 for reinforced or double insulation |
| Ambient temperature | connection side -20 °C ... +100 °C actuating side -20 °C ... +55 °C |
| Flammability | UL 94 (actuator: V-0, socket: V-1, housing: V-2) |
| Heat and fire resistance | 850 °C (category D) |
| Material | actuator: PC housing: PA / PA glass fiber-reinforced connections: silver-plated |
| Plug force of the terminals | ≤ 80 N |
| Approval marks |  /  /  |
| Suitable for appliances of protection class II | |



SERIES 1683 - SINGLE AND DOUBLE-POLE PUSHBUTTON SWITCHES

TO 16 A 250 V AC

|  single-pole | | Voltage lamp in V | Actuator color / printing | 16 (4) A 250 V AC 1E4 | 12 (8) A 250 V AC 1E4 | 10 (8) A 250 V AC 5E4 | 12 A 125 - 250 V AC 1/2 HP | Connection type | Connection description | Contact distance mm | Contact material | Free position (FP) max. in mm | Operating position (OP) in mm | Permissible total travel position (TP) in mm | Miscellaneous | Actuator description | Stock version |
|--|--|-------------------|---|-----------------------|-----------------------|-----------------------|----------------------------|---|------------------------|---------------------|------------------|-------------------------------|-------------------------------|--|------------------|----------------------|---------------|
| ON/OFF switch (SPST) | | | | | | | | | | | | | | | | | |
| 1686.1101 | | 230 |  | ● | ● | ● | ● |  | 4.8 | ≈ 3 | Ag | 23.9 | 20.85 | 19.7 | | | ● |
| 1686.1304 | | 230 |  | ● | ● | ● | ● |  | 4.8 | ≈ 3 | Ag | 23.9 | 20.85 | 19.7 | | | |
| 1683.1101 | | |  | ● | ● | ● | ● |  | 4.8 | ≈ 3 | Ag | 23.9 | 20.85 | 19.7 | | | |
| 1683.1701 | | |  | ● | ● | ● | ● |  | 4.8 | ≈ 3 | Ag | 23.5 | 20.45 | 19.3 | snap-on actuator | | |
| 1683.1801 | | |  | ● | ● | ● | ● |  | 4.8 | ≈ 3 | Ag | 23.5 | 20.45 | 19.3 | | | |
| 1683.3101 | | |  | ● | ● | ● | ● |  | 4.8 horizontal | ≈ 3 | Ag | 23.5 | 20.45 | 19.3 | | | |
| Normally open contact (SPNO) | | | | | | | | | | | | | | | | | |
| 1683.1201 | | |  | ● | ● | ● | ● |  | 4.8 | ≈ 3 | Ag | 23.9 | 20.85 | 19.7 | | | ● |
| 1683.1802 | | |  | ● | ● | ● | ● |  | 4.8 | ≈ 3 | Ag | 23.5 | 20.45 | 19.3 | | | |
| 1683.3601 | | |  | ● | ● | ● | ● |  | 4.8 horizontal | ≈ 3 | Ag | 23.5 | 20.45 | 19.3 | snap-on actuator | | |
|  double-pole | | Voltage lamp in V | Actuator color / printing | 16 (4) A 250 V AC 1E4 | 12 (8) A 250 V AC 1E4 | 10 (8) A 250 V AC 5E4 | 12 A 125 - 250 V AC 1/2 HP | Connection type | Connection description | Contact distance mm | Contact material | Free position (FP) max. in mm | Operating position (OP) in mm | Permissible total travel position (TP) in mm | Miscellaneous | Actuator description | Stock version |
| ON/OFF switch (DPST) | | | | | | | | | | | | | | | | | |
| 1687.1104 | | 230 |  | ● | ● | ● | ● |  | 4.8 | ≈ 3 | Ag | 23.9 | 20.85 | 19.7 | | | ● |
| 1684.1101 | | |  | ● | ● | ● | ● |  | 4.8 | ≈ 3 | Ag | 23.9 | 20.85 | 19.7 | | | ● |
| 1684.1104 | | |  | ● | ● | ● | ● |  | 4.8 | ≈ 3 | Ag | 23.9 | 20.85 | 19.7 | | | |
| 1684.1701 | | |  | ● | ● | ● | ● |  | 4.8 | ≈ 3 | Ag | 23.5 | 20.45 | 19.3 | snap-on actuator | | |
| 1684.1801 | | |  | ● | ● | ● | ● |  | 4.8 | ≈ 3 | Ag | 23.5 | 20.45 | 19.3 | | | |
| 1684.2701 | | |  | ● | ● | ● | ● |  | vertical | ≈ 3 | Ag | 23.5 | 20.45 | 19.3 | snap-on actuator | | |
| Normally open contact (DPNO) | | | | | | | | | | | | | | | | | |
| 1684.1201 | | |  | ● | ● | ● | ● |  | 4.8 | ≈ 3 | Ag | 23.9 | 20.85 | 19.7 | | | ● |
| 1684.1802 | | |  | ● | ● | ● | ● |  | 4.8 | ≈ 3 | Ag | 23.5 | ≤ 20.45 | 19.3 | | | |

ROCKERSWITCHES
 PUSHBUTTON SWITCHES
 TOGGLE SWITCHES
 SLIDE SWITCHES
 ROTARY SWITCHES
 FOOT SWITCHES
 POWER TOOL SWITCHES
 TACT AND KEY SWITCHES
 SNAP-ACTION SWITCHES
 MICRO-SIGNAL SWITCHES
 SENSORS

SERIES 1683 - SINGLE AND DOUBLE-POLE PUSHBUTTON SWITCHES

TO 16 A 250 V AC



Basic type 1683
single-pole
non-illuminated

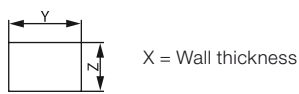

| X | Y | Z |
|---------------|----------------------|----------------------|
| 0.75 ... 1.25 | 19.2 ^{-0.1} | 12.9 ^{+0.1} |
| 1.25 ... 2 | 19.4 ^{-0.1} | 12.9 ^{+0.1} |
| 2 ... 3 | 19.8 ^{-0.1} | 12.9 ^{+0.1} |

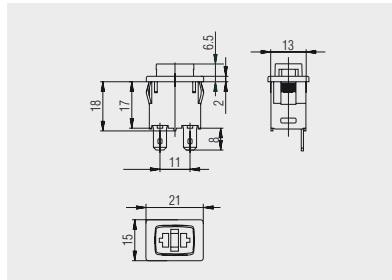

Quick-connect terminal 4.8

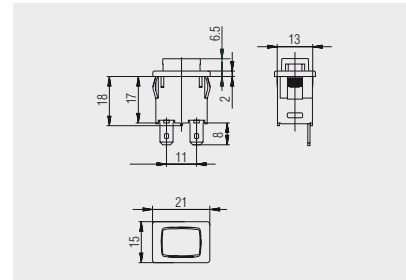

Quick-connect terminal 4.8

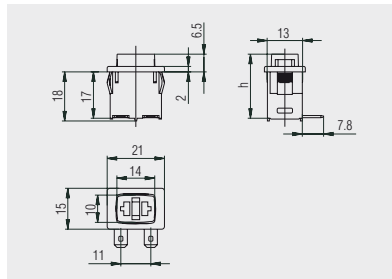

Quick-connect terminal 4.8
horizontal

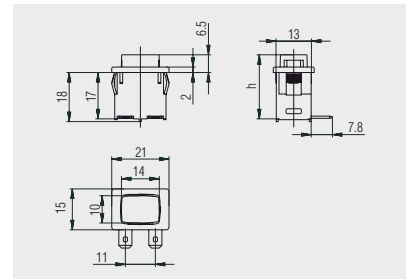

Quick-connect terminal 4.8
horizontal



Basic types 1684,1686 and 1687
single and double-pole
illuminated / non-illuminated

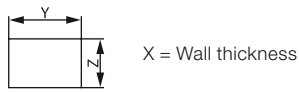

| X | Y | Z |
|---------------|----------------------|----------------------|
| 0.75 ... 1.25 | 19.2 ^{-0.1} | 12.9 ^{+0.1} |
| 1.25 ... 2 | 19.4 ^{-0.1} | 12.9 ^{+0.1} |
| 2 ... 3 | 19.8 ^{-0.1} | 12.9 ^{+0.1} |

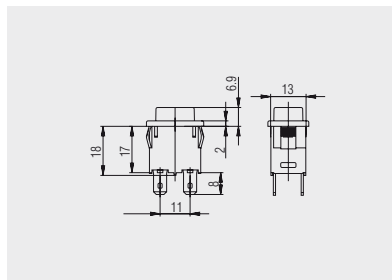

Quick-connect terminal 4.8
1684.1101, 1684.1104, 1684.1201,
basic types 1687 and 1686

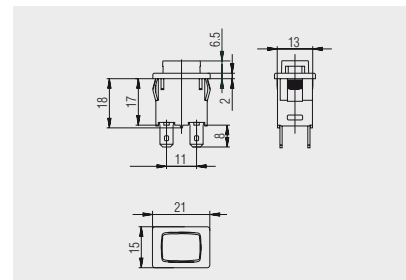

Quick-connect terminal 4.8
basic type 1684

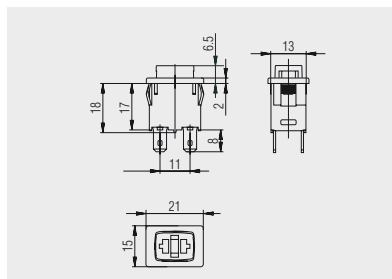

Quick-connect terminal 4.8
basic type 1684

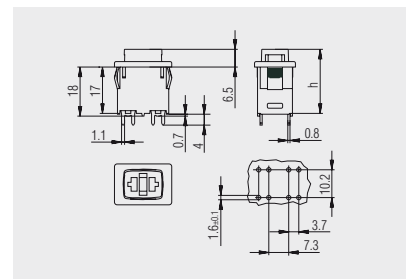

PCB terminal vertical
1684.2701



Protection cap
203.701.011

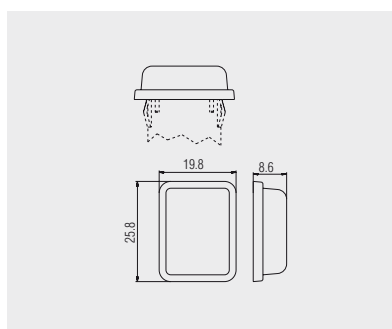

Transparent PVC-protection cap for
dust and water protection from the
actuation side

ROCKER SWITCHES

PUSHBUTTON SWITCHES

TOGGLE SWITCHES

SLIDE SWITCHES

ROTARY SWITCHES

FOOT SWITCHES

POWER TOOL SWITCHES

TACT AND KEY SWITCHES

SNAP-ACTION SWITCHES

MICRO-SIGNAL SWITCHES

SENSORS