



Micro MATE-N-LOK 3mm Connector System

Product Facts

- Wire-to-wire and wire-to-board pin and receptacle connector system
- Contacts are on 3 mm [.118] centerline spacing
- 2-12 contact positions – single row
- 2-24 contact positions – dual row
- Panel mount or free hanging wire-to-wire configurations
- Dual beam contact design for reliable interconnection
- Contacts accept 24-20 [0.2-0.6] and 30-26 [0.05-0.15] AWG wire with insulation diameter of .060 [1.52] maximum
- Contacts available in strip form or loose piece
- Pcb mount pin header assemblies in both vertical and right-angle styles
- Surface mount or through-hole pcb pin header attachment
- Pcb headers are IR reflow process compatible
- Recognized under the Component Program of Underwriters Laboratories Inc.  us to US and Canadian Standards, File No. E28476
- Passed Tests for VDE under Registration Number 40005280/Continuous Surveillance 

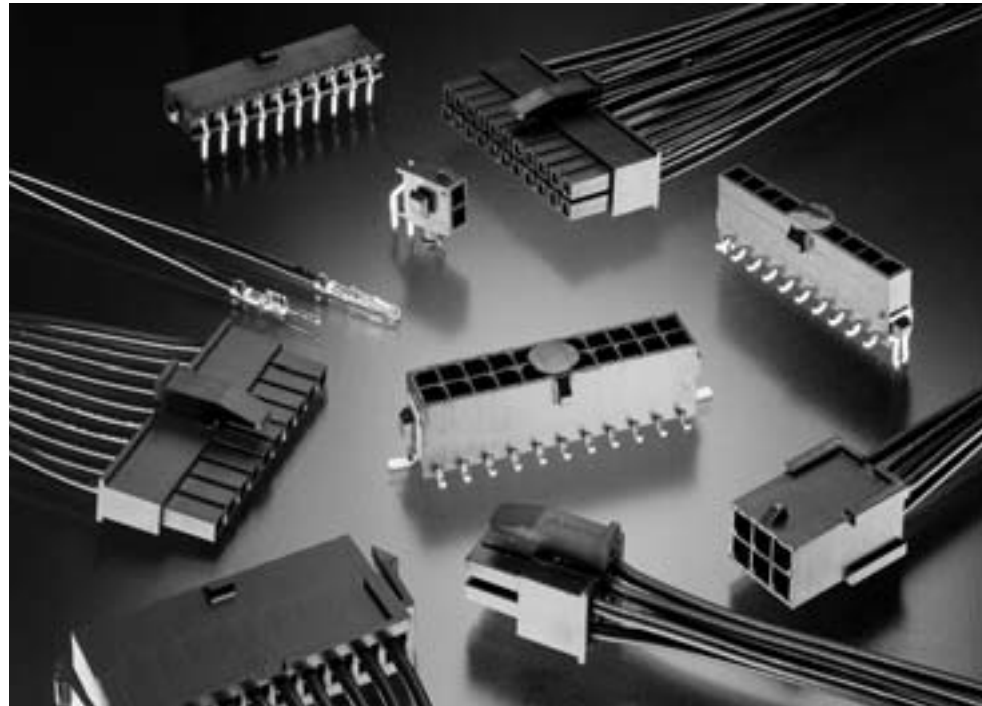

The Micro MATE-N-LOK 3 mm Connector System is a wire-to-wire and wire-to-board connector system with contacts on a 3 mm [.118] centerline. Both single-row and dual-row configurations are available. Crimp, snap-in pin and receptacle contacts are used to terminate 24-20 [0.2-0.6] and 30-26 [0.05-0.15] AWG wire. Plug and receptacle housings allow wire-to-wire and wire-to-panel configurations.

Header assemblies for wire-to-board interconnections include vertical and right-angle components. These IR reflow process compatible headers are available in through-hole and surface mount configurations.

Typical uses of the Micro MATE-N-LOK 3 mm Connector System include the appliance, instrumentation, industrial machinery, home equipment, and security system industries.

Technical Documents

Application Specification

114-13000 Micro MATE-N-LOK Connectors

Product Specification

108-1836 3 mm Micro MATE-N-LOK Connector

Performance Characteristics

Voltage Rating—250 vac

Current Rating—5 amp max. on 20 AWG wire

Contact Resistance—20 milliohms max. final

Dielectric Withstanding Voltage—1500 VAC

Insulation Resistance—1000 megohms min.

Operating Temperature—-40°C to +105°C

Mating Force—1.5lb [6.67N] max per contact

Micro MATE-N-LOK 3mm Connector System (Continued)

Connector Application 19-21
Crimp, Snap-In Contacts 22

Receptacle Housings
Single Row 23
Dual Row 24

Plug Housings
Single Row, Free Hanging 25
Single Row, Panel Mount 26
Dual Row, Free Hanging 27
Dual Row, Panel Mount 28

Vertical Header Assemblies
Single Row, Through-Hole, with Retention Feature
on Solder-tail and Polarization Feature to PCB 29
Single Row, Through-Hole, with Metal Through-Hole Hold-down 30
Single Row, Surface Mount, with Metal Through-Hole Hold-down 31
Single Row, Surface Mount, with Surface Mount Hold-down 32
Dual Row, Through-Hole, with Retention Feature on Solder-tail 33
Dual Row, Through-Hole, with Retention Feature
on Solder-tail and Metal Through-Hole Hold-down 34
Dual Row, Surface Mount, with Metal Through-Hole Hold-down 35
Dual Row, Surface Mount, with Surface Mount Hold-down 36

Right-Angle Header Assemblies
Single Row, Through-Hole, with Metal Through-Hole Hold-down 37
Single Row, Through-Hole, with Plastic Boardlock 38
Single Row, Surface Mount, with Metal Through-Hole Hold-down 39
Single Row, Surface Mount, with Surface Mount Hold-down 40
Single Row, Surface Mount, with Plastic Boardlock 41
Dual Row, Through-Hole, with Metal Through-Hole Hold-down 42
Dual Row, Through-Hole, with Plastic Boardlock 43
Dual Row, Surface Mount, with Metal Through-Hole Hold-down 44
Dual Row, Surface Mount, with Plastic Boardlock 45
Dual Row, Surface Mount, with Surface Mount Hold-down 46

Current Rating Verification for 30°C Maximum Temperature Rise 100% Energized

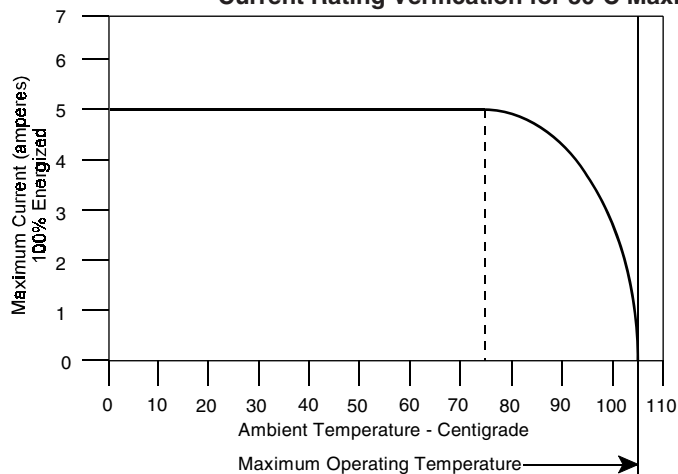

Number of Circuit Positions	Multiplication Factor	
	Wire Size (AWG)	
2 to 6	28	20
	0.40	1
8 to 20	0.40	0.85
	22 to 24	0.36

To determine acceptable current carrying capacity for connector size and wire gage indicated, use the Multiplication Factor from the chart above and multiply it times the Base rated Current at the maximum ambient operating temperature shown in the current rating figure.

Micro MATE-N-LOK 3mm Connector System (Continued)

**Connector Application —
Wire-to-Wire and
Wire-to-Panel**

Single Row

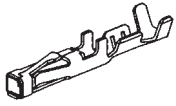
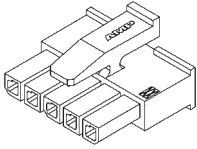
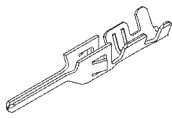
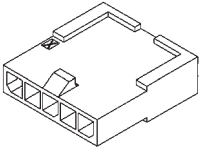
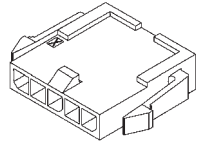
Receptacle		Plug	
Contact	Housing	Contact	Housing
 <p>794606-□, 794607-□, 794610-□, 794611-□ Page 22</p>	 <p>1445022-□ Page 23</p>	 <p>794608-□, 794609-□, 794612-□, 794613-□ Page 22</p>	 <p>Free Hanging 1445049-□ Page 25</p>  <p>Panel Mount 1445048-□ Page 26</p>

Dual Row

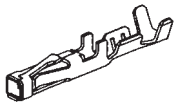
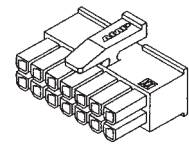
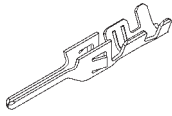
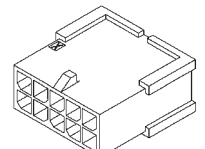
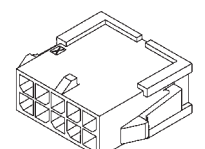

Receptacle		Plug	
Contact	Housing	Contact	Housing
 <p>794606-□, 794607-□, 794610-□, 794611-□ Page 22</p>	 <p>794617-□ Page 24</p>	 <p>794608-□, 794609-□, 794612-□, 794613-□ Page 22</p>	 <p>Free Hanging 794616-□ Page 27</p>  <p>Panel Mount 794615-□ Page 28</p>

High Density
.118 [3.00] Centerline

Micro MATE-N-LOK 3mm Connector System (Continued)

**Connector Application —
Wire-to-PCB**

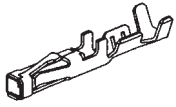
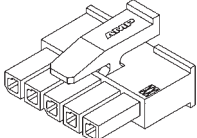
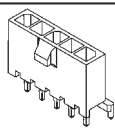
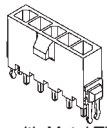
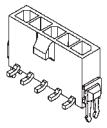
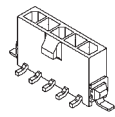
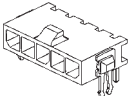
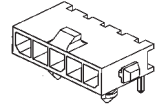
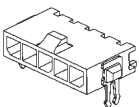
Single Row

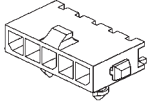
Receptacle		Header
Contact	Housing	
 <p>794606-□, 794607-□, 794610-□, 794611-□ Page 22</p>	 <p>1445022-□ Page 23</p>	 <p>Vertical Through-Hole, with Retention Feature on Solder-tail and Polarization Feature to PCB 1445050-□, 1445084-□, 1445093-□ (Page 29)</p>  <p>Vertical Through-Hole, with Metal Through-Hole Hold-down 1445051-□, 1445085-□, 1445094-□ (Page 30)</p>  <p>Vertical Surface Mount, with Metal Through-Hole Hold-down 1445052-□, 1445086-□, 1445095-□ (Page 31)</p>  <p>Vertical Surface Mount, with Surface Mount Hold-down 1445053-□, 1445087-□, 1445096-□ (Page 32)</p>  <p>Right-angle, Through-Hole, with Metal Through-Hole Hold-down 1445054-□, 1445088-□, 1445097-□ (Page 37)</p>  <p>Right-angle, Through-Hole, with Plastic Boardlock 1445055-□, 1445089-□, 1445098-□ (Page 38)</p>  <p>Right-angle, Surface Mount, with Metal Through-Hole Hold-down 1445056-□, 1445090-□, 1445099-□ (Page 39)</p>  <p>Right-angle, Surface Mount, with Surface Mount Hold-down 1445057-□, 1445091-□, 1445100-□ (Page 40)</p>  <p>Right-angle, Surface Mount, and Plastic Boardlock 1445058-□, 1445092-□, 1445101-□ (Page 41)</p>

Micro MATE-N-LOK 3mm Connector System (Continued)

**Connector Application —
Wire-to-PCB**

Dual Row

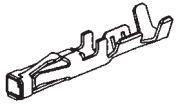
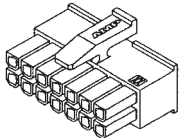
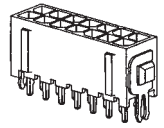
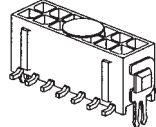
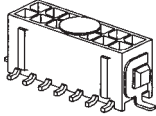
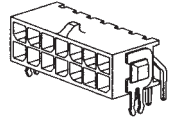
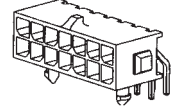
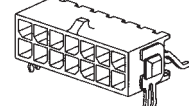
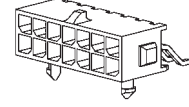
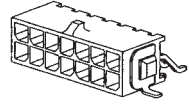
Receptacle		Header
Contact	Housing	
 <p>794606-□, 794607-□, 794610-□, 794611-□ Page 22</p>	 <p>794617-□ Page 24</p>	 <p>Vertical Through-Hole, with Retention Feature on Solder-tail and Optional Metal Through-Hole Hold-down 794630-□, 794631-□, 794632-□, (Page 33) 794680-□, 794681-□, 794682-□ (Page 34)</p>  <p>Vertical Surface Mount, with Metal Through-Hole Hold-down 794633-□, 794634-□, 794635-□ (Page 35)</p>  <p>Vertical Surface Mount, with Surface Mount Hold-down 794636-□, 794637-□, 794638-□ (Page 36)</p>  <p>Right-angle, Through-Hole, with Metal Through-Hole Hold-down 794677-□, 794678-□, 794679-□ (Page 42)</p>  <p>Right-angle, Through-Hole, with Plastic Boardlock 794618-□, 794619-□, 794620-□ (Page 43)</p>  <p>Right-angle, Surface Mount, with Metal Through-Hole Hold-down 794624-□, 794625-□, 794626-□ (Page 44)</p>  <p>Right-angle, Surface Mount, with Plastic Boardlock 794621-□, 794622-□, 794623-□ (Page 45)</p>  <p>Right-angle, Surface Mount, with Surface Mount Hold-down 794627-□, 794628-□, 794629-□ (Page 46)</p>

Micro MATE-N-LOK 3mm Connector System (Continued)

Crimp, Snap-In Contacts

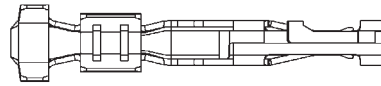

Material and Finish

Receptacle — Phosphor Bronze

Plug — Brass

Plating A — .000100 (.000254) minimum bright tin entire stock over .000050 (.000127) minimum nickel entire stock

Plating B — .000015 (.000038) minimum gold in localized gold plate area. .000100 (.000254) minimum bright tin in localized tin plate area, both over .000050 (.000127) minimum nickel on entire stock

Plating C — .000030 (.000076) minimum gold in localized gold plate area. .000100 (.000254) minimum bright tin in localized tin plate area, both over .000050 (.000127) minimum nickel on entire stock

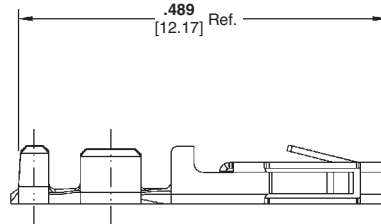

Related Product Data

Connectors used with:

Receptacle Contacts used with Receptacle Housings — pages 23-24

Plug Contacts used with Plug Housings — pages 25-28

Application Tooling— pages 201-204

Receptacle Contacts

Wire Size Range AWG [mm ²]	Ins. Dia. Range	Finish	Contact Part Numbers		Tooling Part Numbers	
			Strip Form	Loose Piece	Applicator	Hand Tool
20-24 0.50 - 0.20	.035 - .060 0.89-1.52	Plating A	794606-1	794610-1	680893-□*	91501-1
		Plating B	1-794606-1	1-794610-1		
		Plating C	1-794606-2	1-794610-2		
26-30 0.12 - 0.05	.035 - .060 0.89-1.52	Plating A	794607-1	794611-1	680894-□*	91502-1
		Plating B	1-794607-1	1-794611-1		
		Plating C	1-794607-2	1-794611-2		

*1=AMPOMATOR CLS Machine, 2=AMP-O-LECTRIC Model K Terminator, 3=AMP-O-LECTRIC Model G Terminator

Note: All part numbers are RoHS Compliant.

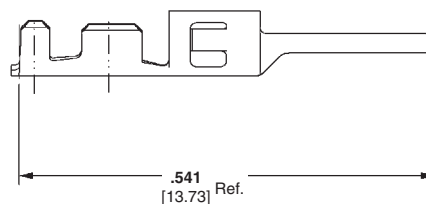
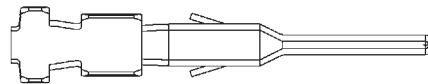

Plug Contacts

Wire Size Range AWG [mm ²]	Ins. Dia. Range	Finish	Contact Part Numbers		Tooling Part Numbers	
			Strip Form	Loose Piece	Applicator	Hand Tool
20-24 0.50 - 0.20	.035 - .060 0.89-1.52	Plating A	1-794608-0	1-794612-0	1385194-□*	91501-1
		Plating B	1-794608-1	1-794612-1		
		Plating C	1-794608-2	1-794612-2		
26-30 0.12 - 0.05	.035 - .060 0.89-1.52	Plating A	1-794609-0	1-794613-0	1385377-□*	91502-1
		Plating B	1-794609-1	1-794613-1		
		Plating C	1-794609-2	1-794613-2		

*1=AMPOMATOR CLS Machine, 2=AMP-O-LECTRIC Model K Terminator, 3=AMP-O-LECTRIC Model G Terminator

Note: All part numbers are RoHS Compliant.

Contact Extraction Tools

Part Number 843996-6 for Receptacle Contacts Part Number 1586344-1 for Plug Contacts

Receptacle Housings

Single Row

Material

Nylon, Black
Flammability Rating—UL 94V-0

Related Product Data

Contacts:

Receptacle Contacts—page 22

Mateable Housings and Headers:

Single Row Plug Housings—
pages 25-26
Single Row Vertical Pin Header
Assemblies—pages 29-32
Single Row Right-Angle Pin Header
Assemblies—pages 37-41

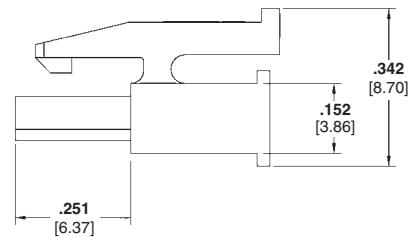
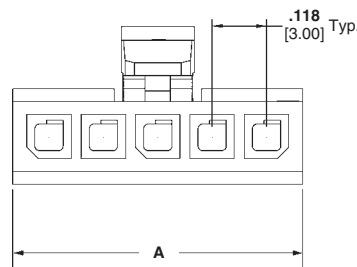
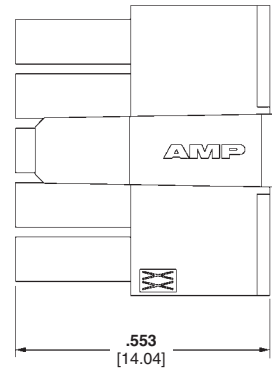

Number of Circuits	Dimension A	Part Numbers
2	.276 7.00	1445022-2
3	.394 10.00	1445022-3
4	.512 13.00	1445022-4
5	.630 16.00	1445022-5
6	.748 19.00	1445022-6
7	.866 22.00	1445022-7
8	.984 25.00	1445022-8
9	1.102 28.00	1445022-9
10	1.220 31.00	1-1445022-0
11	1.339 34.00	1-1445022-1
12	1.457 37.00	1-1445022-2

Note: All part numbers are RoHS Compliant.

Receptacle Housings
(Continued)

Dual Row

Material

Nylon, Black
Flammability Rating—UL 94V-0

Related Product Data

Contacts:

Receptacle Contacts—page 22

Mateable Housings and Headers:

Dual Row Plug Housings—pages 27-28
Dual Row Vertical Pin Header Assemblies—pages 33-36
Dual Row Right-Angle Pin Header Assemblies—pages 42-46

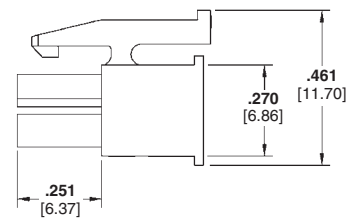
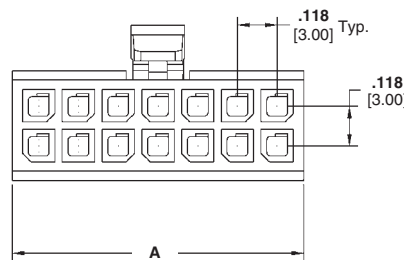
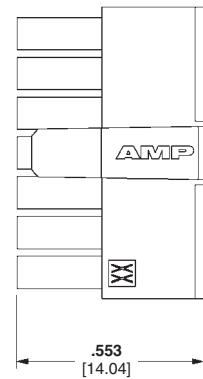

Number of Circuits	Dimension A	Part Numbers
2	.157 4.00	794617-2
4	.276 7.00	794617-4
6	.394 10.00	794617-6
8	.512 13.00	794617-8
10	.630 16.00	1-794617-0
12	.748 19.00	1-794617-2
14	.866 22.00	1-794617-4
16	.984 25.00	1-794617-6
18	1.102 28.00	1-794617-8
20	1.220 31.00	2-794617-0
22	1.339 34.00	2-794617-2
24	1.457 37.00	2-794617-4

Note: All part numbers are RoHS Compliant.

Plug Housings

Single Row, Free Hanging

Material

Nylon, Black
Flammability Rating—UL 94V-0

Related Product Data

Contacts:

Plug Contacts—page 22

Mateable Housings:

Single Row Receptacle Housings—
page 23

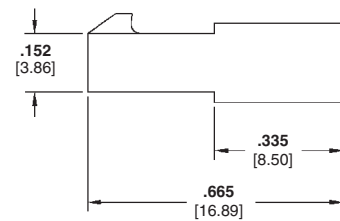
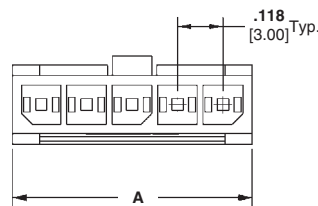
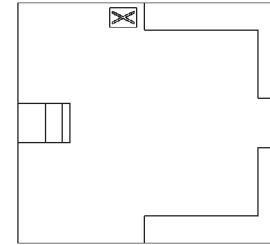

Number of Circuits	Dimension A	Part Numbers
2	.270 6.85	1445049-2
3	.388 9.85	1445049-3
4	.506 12.85	1445049-4
5	.624 15.85	1445049-5
6	.742 18.85	1445049-6
7	.860 21.85	1445049-7
8	.978 24.85	1445049-8
9	1.096 27.85	1445049-9
10	1.215 30.85	1-1445049-0
11	1.333 33.85	1-1445049-1
12	1.451 36.85	1-1445049-2

Note: All part numbers are RoHS Compliant.

Plug Housings (Continued)

Single Row, Panel Mount

Material

Nylon, Black
Flammability Rating—UL 94V-0

Related Product Data

Contacts:

Plug Contacts—page 22

Mateable Housings:

Single Row Receptacle Housings—
page 23

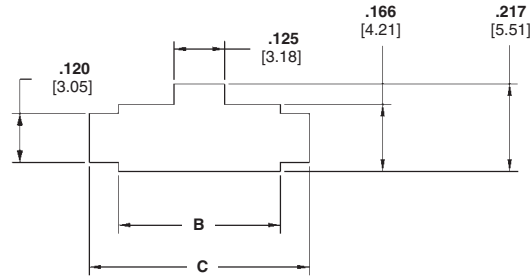

Recommended Panel Cutout*

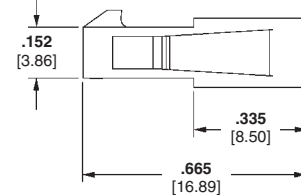
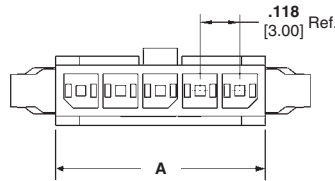
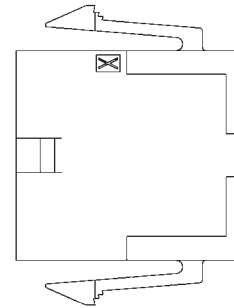

Number of Circuits	Dimensions			Part Numbers
	A	B	C	
2	.270 6.85	.283 7.20	.428 10.88	1445048-2
3	.388 9.85	.402 10.20	.546 13.88	1445048-3
4	.506 12.85	.520 13.20	.665 16.88	1445048-4
5	.624 15.85	.638 16.20	.783 19.88	1445048-5
6	.742 18.85	.756 19.20	.901 22.88	1445048-6
7	.860 21.85	.874 22.20	1.019 25.88	1445048-7
8	.978 24.85	.992 25.20	1.137 28.88	1445048-8
9	1.096 27.85	1.110 28.20	1.255 31.88	1445048-9
10	1.215 30.85	1.228 31.20	1.373 34.88	1-1445048-0
11	1.333 33.85	1.346 34.20	1.491 37.88	1-1445048-1
12	1.451 36.85	1.465 37.20	1.609 40.88	1-1445048-2

*Recommended panel thickness .062-.091 [1.57-2.30]. Always consult customer drawing for panel cutout dimensions.

Note: All part numbers are RoHS Compliant.

Plug Housings (Continued)

Dual Row, Free Hanging

Material

Nylon, Black
Flammability Rating—UL 94V-0

Related Product Data

Contacts:

Plug Contacts—page 22

Mateable Housings:

Dual Row Receptacle Housings—
page 24

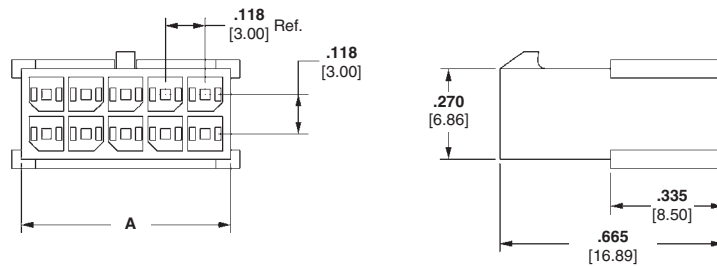
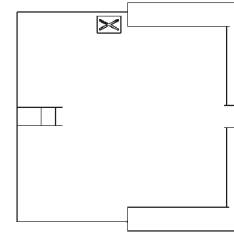

Number of Circuits	Dimension A	Part Numbers
2	.157 3.85	794616-2
4	.276 6.85	794616-4
6	.394 9.85	794616-6
8	.512 12.85	794616-8
10	.630 15.85	1-794616-0
12	.748 18.85	1-794616-2
14	.866 21.85	1-794616-4
16	.984 24.85	1-794616-6
18	1.102 27.85	1-794616-8
20	1.220 30.85	2-794616-0
22	1.339 33.85	2-794616-2
24	1.457 36.85	2-794616-4

Note: All part numbers are RoHS Compliant.

High Density
.118 [3.00] Centerline

Plug Housings (Continued)

Dual Row, Panel Mount

Material

Nylon, Black
Flammability Rating—UL 94V-0

Related Product Data

Contacts:

Plug Contacts—page 22

Mateable Housings:

Dual Row Receptacle Housings—
page 24

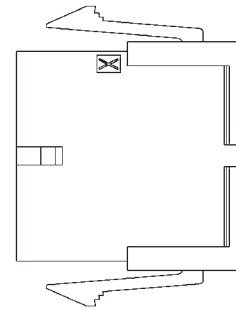
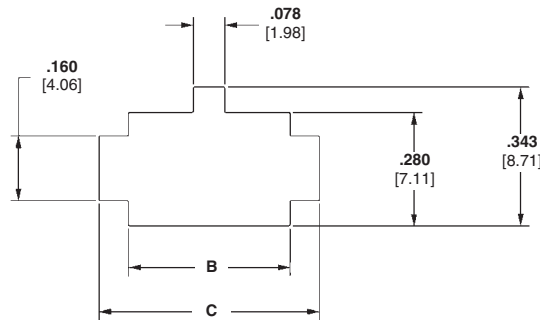

Recommended Panel Cutout*

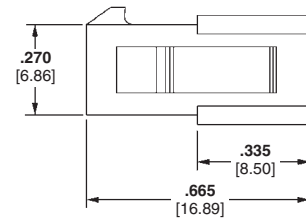
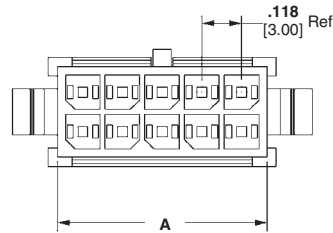

Number of Circuits	Dimensions			Part Numbers
	A	B	C	
2	.157 3.85	.165 4.20	.310 7.88	794615-2
4	.276 6.85	.285 7.20	.428 10.88	794615-4
6	.394 9.85	.402 10.20	.546 13.88	794615-6
8	.512 12.85	.520 13.20	.665 16.88	794615-8
10	.630 15.85	.638 16.20	.783 19.88	1-794615-0
12	.748 18.85	.756 19.20	.901 22.88	1-794615-2
14	.866 21.85	.874 22.20	1.019 25.88	1-794615-4
16	.984 24.85	.992 25.20	1.137 28.88	1-794615-6
18	1.102 27.85	1.110 28.20	1.255 31.88	1-794615-8
20	1.220 30.85	1.228 31.20	1.373 34.88	2-794615-0
22	1.339 33.85	1.346 34.20	1.491 37.88	2-794615-2
24	1.457 36.85	1.469 37.20	1.609 40.88	2-794615-4

*Recommended panel thickness .062-.091 [1.57-2.30]. Always consult customer drawing for panel cutout dimensions.

Note: All part numbers are RoHS Compliant.

Vertical Header Assemblies

Single Row, Through-Hole, with Retention Feature on Solder Tail and Polarization Feature to PCB

Material and Finish

Housing — High Temperature Nylon, Black

Flammability Rating — UL 94V-0

Contacts — Brass

Plating A — .000100 [0.00254] min. tin over .000050 [0.00127] min. nickel

Plating B — .000015 [0.00038] gold in mating area, .000100 [0.00254] min. tin in solder area, with entire contact underplated .000050 [0.00127] min. nickel

Plating C — .000030 [0.00076] gold in mating area, .000100 [0.00254] min. tin in solder area, with entire contact underplated .000050 [0.00127] min. nickel

Related Product Data

Mateable Housings:

Single Row Receptacle Housings— page 23

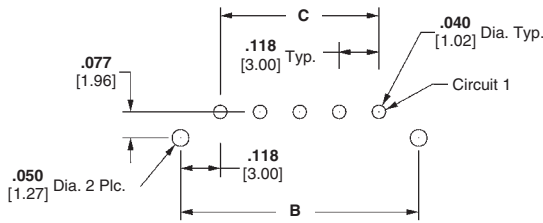
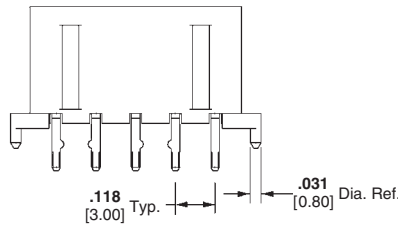
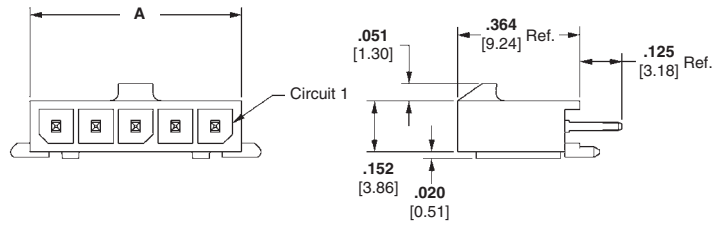

Recommended PC Board Layout*

Number of Circuits	Dimensions			Header Part Numbers			Mates with Receptacle Housing Part Number
	A	B	C	Plating A	Plating B	Plating C	
2	.276 7.00	.360 9.14	.118 3.00	2-1445050-2	2-1445084-2	2-1445093-2	1445022-2
3	.394 10.00	.478 12.14	.236 6.00	2-1445050-3	2-1445084-3	2-1445093-3	1445022-3
4	.512 13.00	.596 15.14	.354 9.00	2-1445050-4	2-1445084-4	2-1445093-4	1445022-4
5	.630 16.00	.714 18.14	.472 12.00	2-1445050-5	2-1445084-5	2-1445093-5	1445022-5
6	.748 19.00	.832 21.14	.591 15.00	2-1445050-6	2-1445084-6	2-1445093-6	1445022-6
7	.866 22.00	.950 24.14	.709 18.00	2-1445050-7	2-1445084-7	2-1445093-7	1445022-7
8	.984 25.00	1.069 27.14	.827 21.00	2-1445050-8	2-1445084-8	2-1445093-8	1445022-8
9	1.102 28.00	1.187 30.14	.945 24.00	2-1445050-9	2-1445084-9	3-1445093-9	1445022-9
10	1.220 31.00	1.304 33.14	1.063 27.00	3-1445050-0	3-1445084-0	3-1445093-0	1-1445022-0
11	1.339 34.00	1.423 36.14	1.181 30.00	3-1445050-1	3-1445084-1	3-1445093-1	1-1445022-1
12	1.457 37.00	1.541 39.14	1.299 33.00	3-1445050-2	3-1445084-2	3-1445093-2	1-1445022-2

*Recommended PC Board thickness .062 [1.57]. Always consult customer drawing for PC Board layout dimensions.

Note: All part numbers are RoHS Compliant.

Vertical Header Assemblies

(Continued)

Single Row, Through-Hole, with Metal Through-Hole Hold-down

Material and Finish

Housing — High Temperature Nylon, Black

Flammability Rating — UL 94V-0

Contacts — Brass

Plating A — .000100 [0.00254] min. tin over .000050 [0.00127] min. nickel

Plating B — .000015 [0.00038] gold in mating area, .000100 [0.00254] min. tin in solder area, with entire contact underplated .000050 [0.00127] min. nickel

Plating C — .000030 [0.00076] gold in mating area, .000100 [0.00254] min. tin in solder area, with entire contact underplated .000050 [0.00127] min. nickel

Hold-downs — Phosphor Bronze, .000100 [0.00254] min. tin over .000050 [0.00127] min. nickel

Related Product Data

Mateable Housings:

Single Row Receptacle Housing— page 23

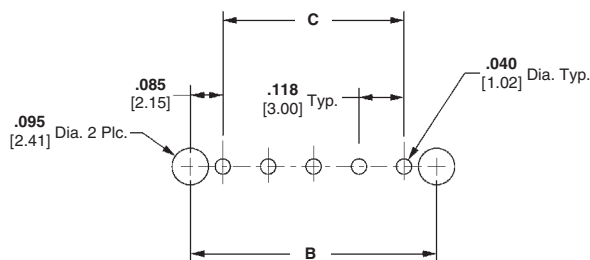
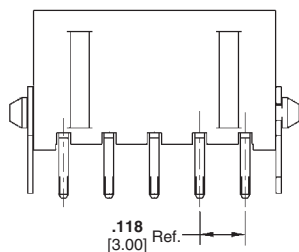
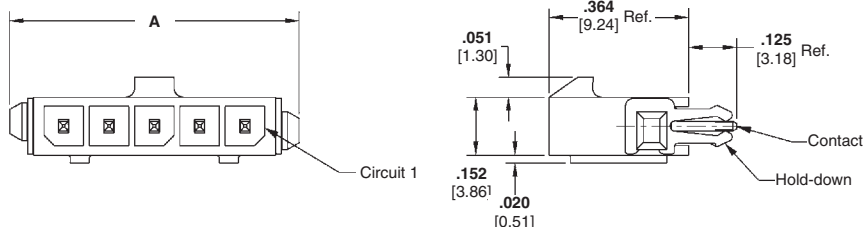

Recommended PC Board Layout*

Number of Circuits	Dimensions			Header Part Numbers			Mates with Receptacle Housing Part Number
	A	B	C	Plating A	Plating B	Plating C	
2	.399 10.14	.293 7.43	.118 3.00	2-1445051-2	2-1445085-2	2-1445094-2	1445022-2
3	.517 13.14	.411 10.43	.236 6.00	2-1445051-3	2-1445085-3	2-1445094-3	1445022-3
4	.635 16.14	.529 13.43	.354 9.00	2-1445051-4	2-1445085-4	2-1445094-4	1445022-4
5	.754 19.14	.647 16.43	.472 12.00	2-1445051-5	2-1445085-5	2-1445094-5	1445022-5
6	.871 22.14	.765 19.43	.591 15.00	2-1445051-6	2-1445085-6	2-1445094-6	1445022-6
7	.990 25.14	.883 22.43	.709 18.00	2-1445051-7	2-1445085-7	2-1445094-7	1445022-7
8	1.108 28.14	1.001 25.43	.827 21.00	2-1445051-8	2-1445085-8	2-1445094-8	1445022-8
9	1.226 31.14	1.119 28.43	.945 24.00	2-1445051-9	2-1445085-9	2-1445094-9	1445022-9
10	1.344 34.14	1.237 31.43	1.063 27.00	3-1445051-0	3-1445085-0	3-1445094-0	1-1445022-0
11	1.462 37.14	1.356 34.43	1.181 30.00	3-1445051-1	3-1445085-1	3-1445094-1	1-1445022-1
12	1.580 40.14	1.474 37.43	1.299 33.00	3-1445051-2	3-1445085-2	3-1445094-2	1-1445022-2

*Recommended PC Board thickness .062 [1.57]. Always consult customer drawing for PC Board layout dimensions.

Note: All part numbers are RoHS Compliant.

Micro MATE-N-LOK 3mm Connector System (Continued)

Vertical Header Assemblies

(Continued)

Single Row, Surface Mount, with Metal Through-Hole Hold-down

Material and Finish

Housing — High Temperature Nylon, Black

Flammability Rating — UL 94V-0

Contacts—Brass

Plating A - .000100 [0.00254] min. tin over .000050 [0.00127] min. nickel

Plating B—.000015 [0.00038] gold in mating area, .000100 [0.00254] min. tin in solder area, with entire contact underplated .000050 [0.00127] min. nickel

Plating C—.000030 [0.00076] gold in mating area, .000100 [0.00254] min. tin in solder area, with entire contact underplated .000050 [0.00127] min. nickel

Hold-downs—Phosphor Bronze, .000100 [0.00254] min. tin over .000050 [0.00127] min. nickel

Related Product Data

Mateable Housings:

Single Row Receptacle Housing—page 23

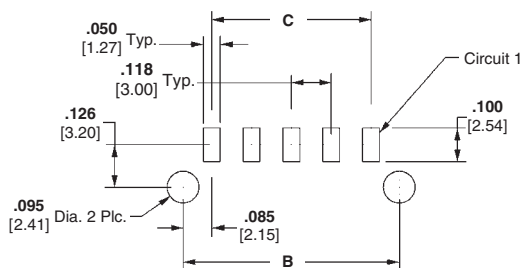
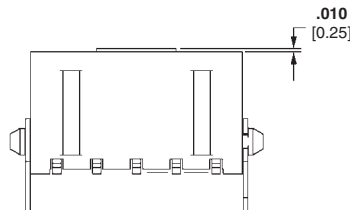
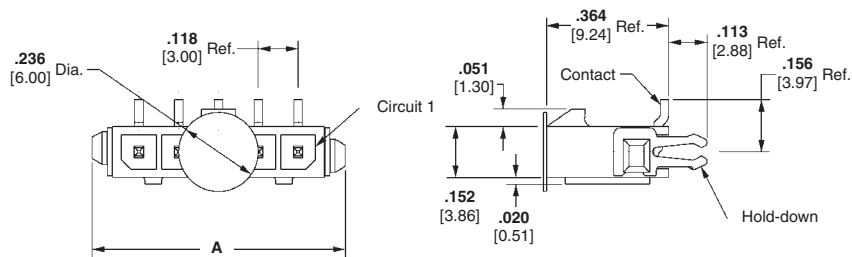

Recommended PC Board Layout*

Number of Circuits	Dimensions			Header Part Numbers			Mates with Receptacle Housing Part Number
	A	B	C	Plating A	Plating B	Plating C	
2	.394 10.00	.293 7.43	.118 3.00	2-1445052-2	2-1445086-2	2-1445095-2	1445022-2
3	.512 13.00	.411 10.43	.236 6.00	2-1445052-3	2-1445086-3	2-1445095-3	1445022-3
4	.630 16.00	.529 13.43	.354 9.00	2-1445052-4	2-1445086-4	2-1445095-4	1445022-4
5	.748 19.00	.647 16.43	.472 12.00	2-1445052-5	2-1445086-5	2-1445095-5	1445022-5
6	.866 22.00	.765 19.43	.591 15.00	2-1445052-6	2-1445086-6	2-1445095-6	1445022-6
7	.984 25.00	.883 22.43	.709 18.00	2-1445052-7	2-1445086-7	2-1445095-7	1445022-7
8	1.102 28.00	1.001 25.43	.827 21.00	2-1445052-8	2-1445086-8	2-1445095-8	1445022-8
9	1.220 31.00	1.119 28.43	.945 24.00	2-1445052-9	2-1445086-9	2-1445095-9	1445022-9
10	1.339 34.00	1.237 31.43	1.063 27.00	3-1445052-0	3-1445086-0	3-1445095-0	1-1445022-0
11	1.457 37.00	1.356 34.43	1.181 30.00	3-1445052-1	3-1445086-1	3-1445095-1	1-1445022-1
12	1.575 40.00	1.474 37.43	1.299 33.00	3-1445052-2	3-1445086-2	3-1445095-2	1-1445022-2

*Recommended PC Board thickness .062 [1.57]. Always consult customer drawing for PC Board layout dimensions.

Note: All part numbers are RoHS Compliant.

Micro MATE-N-LOK 3mm Connector System (Continued)

Vertical Header Assemblies

(Continued)

Single Row, Surface Mount, with Surface Mount Hold-down

Material and Finish

Housing — High Temperature Nylon, Black

Flammability Rating — UL 94V-0

Contacts—Brass

Plating A - .000100 [0.00254] min. tin over .000050 [0.00127] min. nickel

Plating B— .000015 [0.00038] gold in mating area, .000100 [0.00254] min. tin in solder area, with entire contact underplated .000050 [0.00127] min. nickel

Plating C— .000030 [0.00076] gold in mating area, .000100 [0.00254] min. tin in solder area, with entire contact underplated .000050 [0.00127] min. nickel

Hold-downs—Phosphor Bronze, .000100 [0.00254] min. tin over .000050 [0.00127] min. nickel

Related Product Data

Mateable Housings:

Single Row Receptacle Housing— page 23

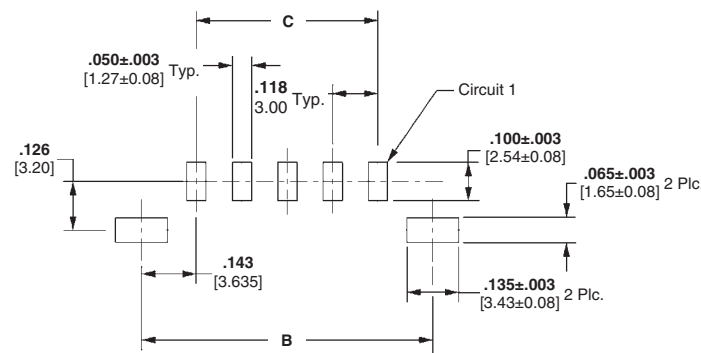
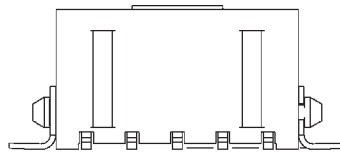
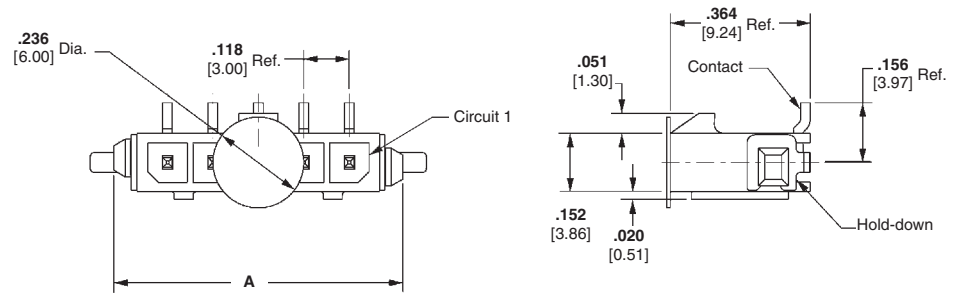

Recommended PC Board Layout*

Number of Circuits	Dimensions			Header Part Numbers			Mates with Receptacle Housing Part Number
	A	B	C	Plating A	Plating B	Plating C	
2	.394 10.00	.410 10.41	.118 3.00	2-1445053-2	2-1445087-2	2-1445096-2	1445022-2
3	.512 13.00	.528 13.41	.236 6.00	2-1445053-3	2-1445087-3	2-1445096-3	1445022-3
4	.630 16.00	.646 16.41	.354 9.00	2-1445053-4	2-1445087-4	2-1445096-4	1445022-4
5	.748 19.00	.765 19.41	.472 12.00	2-1445053-5	2-1445087-5	2-1445096-5	1445022-5
6	.866 22.00	.882 22.41	.591 15.00	2-1445053-6	2-1445087-6	2-1445096-6	1445022-6
7	.984 25.00	1.001 25.41	.709 18.00	2-1445053-7	2-1445087-7	2-1445096-7	1445022-7
8	1.102 28.00	1.119 28.41	.827 21.00	2-1445053-8	2-1445087-8	2-1445096-8	1445022-8
9	1.220 31.00	1.237 31.41	.945 24.00	2-1445053-9	2-1445087-9	2-1445096-9	1445022-9
10	1.339 34.00	1.355 34.41	1.063 27.00	3-1445053-0	3-1445087-0	3-1445096-0	1-1445022-0
11	1.457 37.00	1.473 37.41	1.181 30.00	3-1445053-1	3-1445087-1	3-1445096-1	1-1445022-1
12	1.575 40.00	1.591 40.41	1.299 33.00	3-1445053-2	3-1445087-2	3-1445096-2	1-1445022-2

*Always consult customer drawing for PC Board layout dimensions.

Note: All part numbers are RoHS Compliant.

Micro MATE-N-LOK 3mm Connector System (Continued)

Vertical Header Assemblies

(Continued)

Dual Row, Through-Hole, with Retention Feature on Soldertail

Material and Finish

Housing — High Temperature Nylon, Black

Flammability Rating — UL 94V-0

Contacts—Brass

Plating A—.000100 [0.00254] min. tin over .000050 [0.00127] min. nickel

Plating B—.000015 [0.00038] gold in mating area, .000100 [0.00254] min. tin in solder area, with entire contact underplated .000050 [0.00127] min. nickel

Plating C—.000030 [0.00076] gold in mating area, .000100 [0.00254] min. tin in solder area, with entire contact underplated .000050 [0.00127] min. nickel

Hold-downs—Phosphor Bronze, .000100 [0.00254] min. tin over .000050 [0.00127] min. nickel

Related Product Data

Mateable Housings:

Dual Row Receptacle Housing—page 24

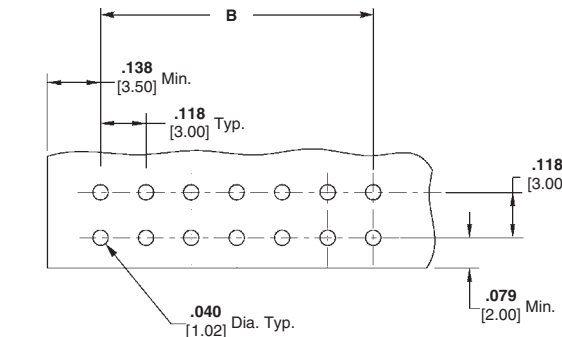
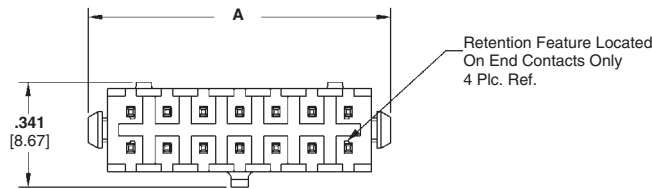
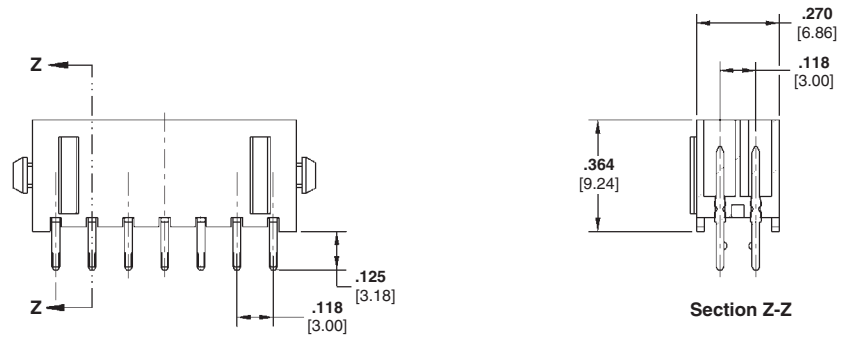

Recommended PC Board Layout*

Number of Circuits	Dimensions		Header Part Numbers			Mates with Receptacle Housing Part Number
	A	B	Plating A	Plating B	Plating C	
2	.276 7.00	—	3-794630-2	3-794631-2	3-794632-2	794617-2
4	.394 10.00	.118 3.00	3-794630-4	3-794631-4	3-794632-4	794617-4
6	.512 13.00	.236 6.00	3-794630-6	3-794631-6	3-794632-6	794617-6
8	.630 16.00	.354 9.00	3-794630-8	3-794631-8	3-794632-8	794617-8
10	.748 19.00	.472 12.00	4-794630-0	4-794631-0	4-794632-0	1-794617-0
12	.866 22.00	.591 15.00	4-794630-2	4-794631-2	4-794632-2	1-794617-2
14	.984 25.00	.709 18.00	4-794630-4	4-794631-4	4-794632-4	1-794617-4
16	1.102 28.00	.827 21.00	4-794630-6	4-794631-6	4-794632-6	1-794617-6
18	1.220 31.00	.945 24.00	4-794630-8	4-794631-8	4-794632-8	1-794617-8
20	1.339 34.00	1.063 27.00	5-794630-0	5-794631-0	5-794632-0	2-794617-0
22	1.457 37.00	1.181 30.00	5-794630-2	5-794631-2	5-794632-2	2-794617-2
24	1.575 40.00	1.299 33.00	5-794630-4	5-794631-4	5-794632-4	2-794617-4

*Recommended PC Board thickness .062 [1.57]. Always consult customer drawing for PC Board layout dimensions.

Note: All part numbers are RoHS Compliant.

Micro MATE-N-LOK 3mm Connector System (Continued)

Vertical Header Assemblies

(Continued)

Dual Row, Through-Hole, with Retention Feature on Soldertail and Metal Through-Hole Hold-down

Material and Finish

Housing—High Temperature Nylon, Black

Flammability Rating—UL 94V-0

Contacts—Brass

Plating A—.000100 [0.00254] min. tin over .000050 [0.00127] min. nickel

Plating B—.000015 [0.00038] gold in mating area, .000100 [0.00254] min. tin in solder area, with entire contact underplated .000050 [0.00127] min. nickel

Plating C—.000030 [0.00076] gold in mating area, .000100 [0.00254] min. tin in solder area, with entire contact underplated .000050 [0.00127] min. nickel

Hold-downs—Phosphor Bronze, .000100 [0.00254] min. tin over .000050 [0.00127] min. nickel

Related Product Data

Mateable Housings:

Dual Row Receptacle Housing—page 24

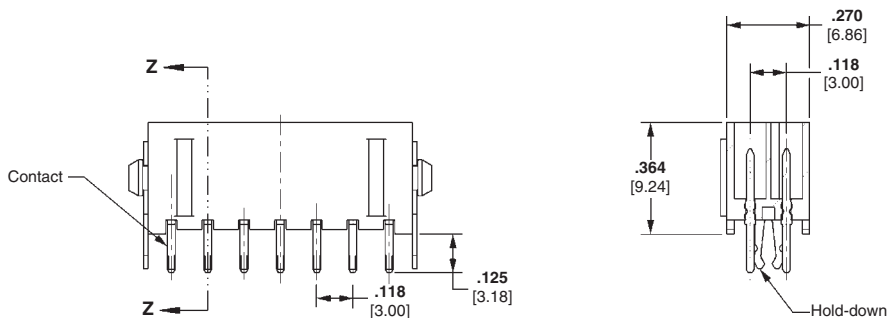

Section Z-Z

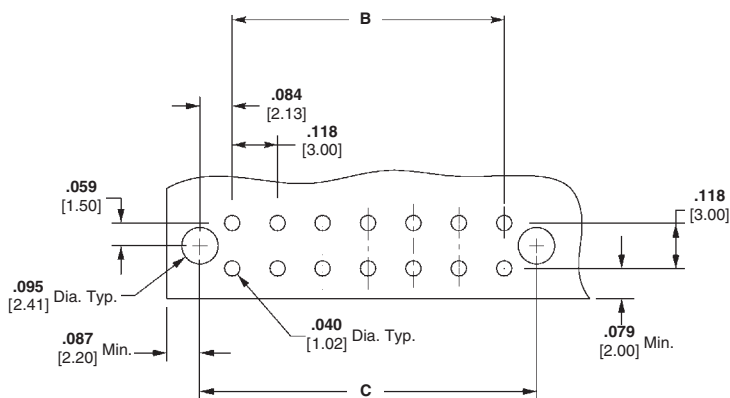
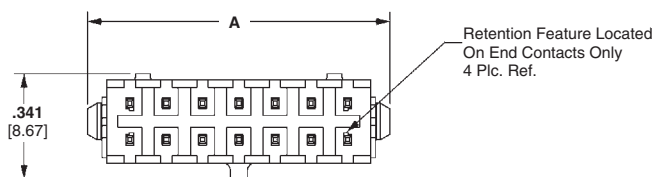

Recommended PC Board Layout*

Number of Circuits	Dimensions			Header Part Numbers			Mates with Receptacle Housing Part Number
	A	B	C	Plating A	Plating B	Plating C	
2	.276 7.00	—	.169 4.30	3-794680-2	3-794681-2	3-794682-2	794617-2
4	.394 10.00	.118 3.00	.287 7.30	3-794680-4	3-794681-4	3-794682-4	794617-4
6	.512 13.00	.236 6.00	.406 10.30	3-794680-6	3-794681-6	3-794682-6	794617-6
8	.630 16.00	.354 9.00	.524 13.30	3-794680-8	3-794681-8	3-794682-8	794617-8
10	.748 19.00	.472 12.00	.642 16.30	4-794680-0	4-794681-0	4-794682-0	1-794617-0
12	.866 22.00	.591 15.00	.760 19.30	4-794680-2	4-794681-2	4-794682-2	1-794617-2
14	.984 25.00	.709 18.00	.878 22.30	4-794680-4	4-794681-4	4-794682-4	1-794617-4
16	1.102 28.00	.827 21.00	.996 25.30	4-794680-6	4-794681-6	4-794682-6	1-794617-6
18	1.220 31.00	.945 24.00	1.114 28.30	4-794680-8	4-794681-8	4-794682-8	1-794617-8
20	1.339 34.00	1.063 27.00	1.232 31.30	5-794680-0	5-794681-0	5-794682-0	2-794617-0
22	1.457 37.00	1.181 30.00	1.350 34.30	5-794680-2	5-794681-2	5-794682-2	2-794617-2
24	1.575 40.00	1.299 33.00	1.469 37.30	5-794680-4	5-794681-4	5-794682-4	2-794617-4

*Recommended PC Board thickness .062 [1.57]. Always consult customer drawing for PC Board layout dimensions.

Note: All part numbers are RoHS Compliant.

Micro MATE-N-LOK 3mm Connector System (Continued)

Vertical Header Assemblies

(Continued)

Dual Row, Surface Mount, with Metal Through-Hole Hold-down

Material and Finish

Housing—High Temperature Nylon, Black

Flammability Rating—UL 94V-0

Contacts—Brass

Plating A—.000100 [0.00254] min. tin over .000050 [0.00127] min. nickel

Plating B—.000015 [0.00038] gold in mating area, .000100 [0.00254] min. tin in solder area, with entire contact underplated .000050 [0.00127] min. nickel

Plating C—.000030 [0.00076] gold in mating area, .000100 [0.00254] min. tin in solder area, with entire contact underplated .000050 [0.00127] min. nickel

Hold-downs—Phosphor Bronze, .000100 [0.00254] min. tin over .000050 [0.00127] min. nickel

Pick-up Button—Kapton

Related Product Data

Mateable Housings:

Dual Row Receptacle Housing—page 24

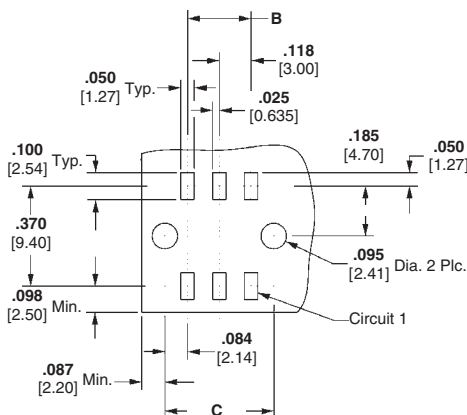
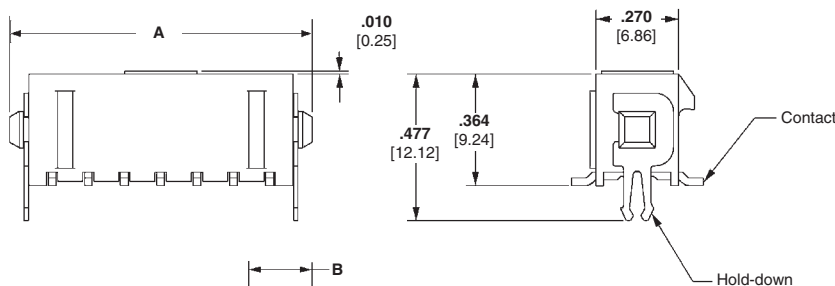
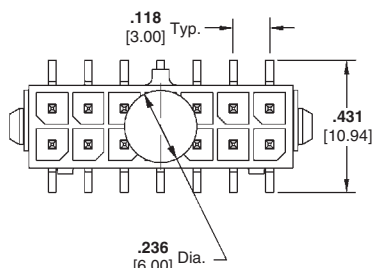

Recommended PC Board Layout*

Number of Circuits	Dimensions			Header Part Numbers			Mates with Receptacle Housing Part Number
	A	B	C	Plating A	Plating B	Plating C	
2	.276 7.00	—	.169 4.30	3-794633-2	3-794634-2	3-794635-2	794617-2
4	.394 10.00	.118 3.00	.287 7.30	3-794633-4	3-794634-4	3-794635-4	794617-4
6	.512 13.00	.236 6.00	.406 10.30	3-794633-6	3-794634-6	3-794635-6	794617-6
8	.630 16.00	.354 9.00	.524 13.30	3-794633-8	3-794634-8	3-794635-8	794617-8
10	.748 19.00	.472 12.00	.642 16.30	4-794633-0	4-794634-0	4-794635-0	1-794617-0
12	.866 22.00	.591 15.00	.760 19.30	4-794633-2	4-794634-2	4-794635-2	1-794617-2
14	.984 25.00	.709 18.00	.878 22.30	4-794633-4	4-794634-4	4-794635-4	1-794617-4
16	1.10 28.00	2.827 21.00	.996 25.30	4-794633-6	4-794634-6	4-794635-6	1-794617-6
18	1.220 31.00	0.945 24.00	1.114 28.30	4-794633-8	4-794634-8	4-794635-8	1-794617-8
20	1.339 34.00	1.063 27.00	1.232 31.30	5-794633-0	5-794634-0	5-794635-0	2-794617-0
22	1.457 37.00	1.181 30.00	1.350 34.30	5-794633-2	5-794634-2	5-794635-2	2-794617-2
24	1.575 40.00	1.299 33.00	1.469 37.30	5-794633-4	5-794634-4	5-794635-4	2-794617-4

*Recommended PC Board thickness .062 [1.57]. Always consult customer drawing for PC Board layout dimensions.

Note: All part numbers are RoHS Compliant.

Micro MATE-N-LOK 3mm Connector System (Continued)

Vertical Header Assemblies

(Continued)

Dual Row, Surface Mount, with Surface Mount Hold-down

Material and Finish

Housing — High Temperature Nylon, Black

Flammability Rating — UL 94V-0

Contacts — Brass

Plating A — .000100 [0.00254] min. tin over .000050 [0.00127] min. nickel

Plating B — .000015 [0.00038] gold in mating area, .000100 [0.00254] min. tin in solder area, with entire contact underplated .000050 [0.00127] min. nickel

Plating C — .000030 [0.00076] gold in mating area, .000100 [0.00254] min. tin in solder area, with entire contact underplated .000050 [0.00127] min. nickel

Hold-downs — Phosphor Bronze, .000100 [0.00254] min. tin over .000050 [0.00127] min. nickel

Pick-up Button — Kapton

Related Product Data

Mateable Housings:

Dual Row Receptacle Housing—page 24

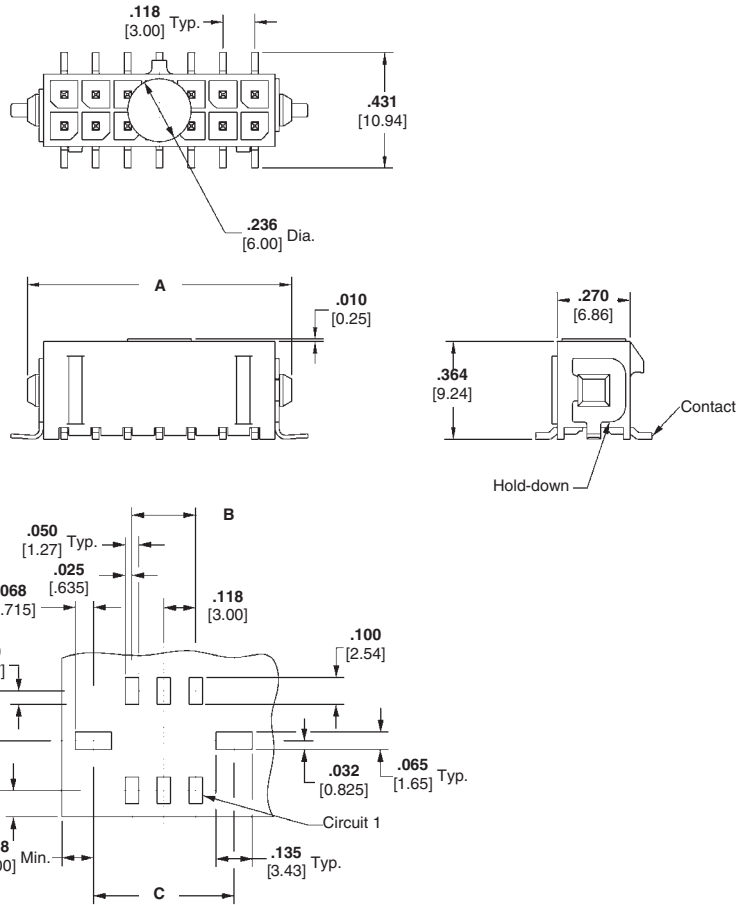

Recommended PC Board Layout*

Number of Circuits	Dimensions			Header Part Numbers			Mates with Receptacle Housing Part Number
	A	B	C	Plating A	Plating B	Plating C	
2	.276 7.00	—	.286 7.27	3-794636-2	3-794637-2	3-794638-2	794617-2
4	.394 10.00	.118 3.00	.404 10.27	3-794636-4	3-794637-4	3-794638-4	794617-4
6	.512 13.00	.236 6.00	.522 13.27	3-794636-6	3-794637-6	3-794638-6	794617-6
8	.630 16.00	.354 9.00	.640 16.27	3-794636-8	3-794637-8	3-794638-8	794617-8
10	.748 19.00	.472 12.00	.758 19.27	4-794636-0	4-794637-0	4-794638-0	1-794617-0
12	.866 22.00	.591 15.00	.876 22.27	4-794636-2	4-794637-2	4-794638-2	1-794617-2
14	.984 25.00	.709 18.00	.994 25.27	4-794636-4	4-794637-4	4-794638-4	1-794617-4
16	1.102 28.00	.827 21.00	1.112 28.27	4-794636-6	4-794637-6	4-794638-6	1-794617-6
18	1.220 31.00	.945 24.00	1.230 31.27	4-794636-8	4-794637-8	4-794638-8	1-794617-8
20	1.339 34.00	1.063 27.00	1.349 34.27	5-794636-0	5-794637-0	5-794638-0	2-794617-0
22	1.457 37.00	1.181 30.00	1.467 37.27	5-794636-2	5-794637-2	5-794638-2	2-794617-2
24	1.575 40.00	1.299 33.00	1.585 40.27	5-794636-4	5-794637-4	5-794638-4	2-794617-4

*Always consult customer drawing for PC Board layout dimensions.

Note: All part numbers are RoHS Compliant.

Right-Angle Header Assemblies

Single Row, Through-Hole, with Metal Through-Hole Hold-down

Material and Finish

Housing—High Temperature Nylon, Black

Flammability Rating—UL 94V-0

Contacts—Brass

Plating A - .000100 [0.00254] min. tin over .000050 [0.00127] min. nickel

Plating B— .000015 [0.00038] gold in mating area, .000100 [0.00254] min. tin in solder area, with entire contact underplated .000050 [0.00127] min. nickel

Plating C— .000030 [0.00076] gold in mating area, .000100 [0.00254] min. tin in solder area, with entire contact underplated .000050 [0.00127] min. nickel

Hold-downs—Phosphor Bronze, .000100 [0.00254] min. tin over .000050 [0.00127] min. nickel

Related Product Data

Mateable Housings:

Single Row Receptacle Housing—
page 23

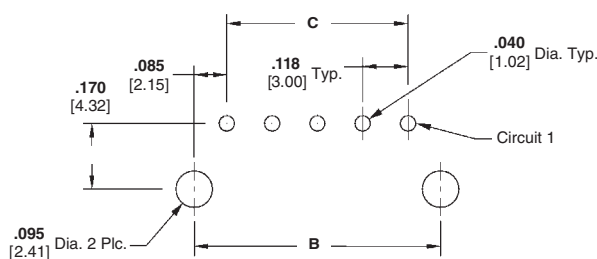
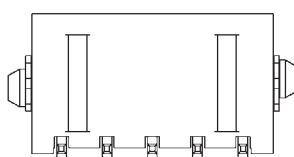
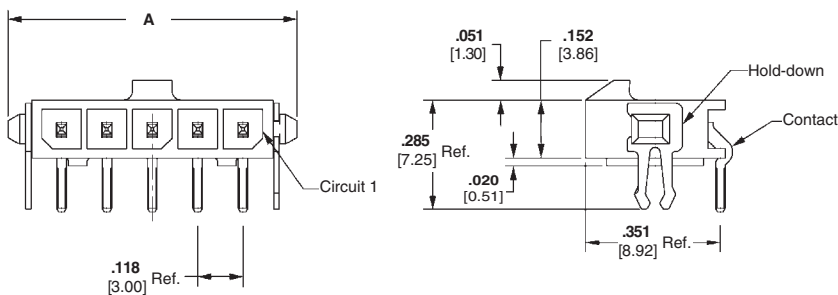

Recommended PC Board Layout*

Number of Circuits	Dimensions			Header Part Numbers			Mates with Receptacle Housing Part Number
	A	B	C	Plating A	Plating B	Plating C	
2	.399 10.14	.293 7.43	.118 3.00	2-1445054-2	2-1445088-2	2-1445097-2	1445022-2
3	.517 13.14	.411 10.43	.236 6.00	2-1445054-3	2-1445088-3	2-1445097-3	1445022-3
4	.635 16.14	.529 13.43	.354 9.00	2-1445054-4	2-1445088-4	2-1445097-4	1445022-4
5	.754 19.14	.647 16.43	.472 12.00	2-1445054-5	2-1445088-5	2-1445097-5	1445022-5
6	.871 22.14	.765 19.43	.591 15.00	2-1445054-6	2-1445088-6	2-1445097-6	1445022-6
7	.990 25.14	.883 22.43	.709 18.00	2-1445054-7	2-1445088-7	2-1445097-7	1445022-7
8	1.108 28.14	1.001 25.43	.827 21.00	2-1445054-8	2-1445088-8	2-1445097-8	1445022-8
9	1.226 31.14	1.119 28.43	.945 24.00	2-1445054-9	2-1445088-9	2-1445097-9	1445022-9
10	1.344 34.14	1.237 31.43	1.063 27.00	3-1445054-0	3-1445088-0	3-1445097-0	1-1445022-0
11	1.462 37.14	1.356 34.43	1.181 30.00	3-1445054-1	3-1445088-1	3-1445097-1	1-1445022-1
12	1.580 40.14	1.474 37.43	1.299 33.00	3-1445054-2	3-1445088-2	3-1445097-2	1-1445022-2

*Recommended PC Board thickness .062 [1.57]. Always consult customer drawing for PC Board layout dimensions.

Note: All part numbers are RoHS Compliant.

Right-Angle Header Assemblies (Continued)

Single Row, Through-Hole, with Plastic Boardlock

Material and Finish

Housing — High Temperature Nylon, Black

Flammability Rating — UL 94V-0

Contacts—Brass

Plating A—.000100 [0.00254] min. tin over .000050 [0.00127] min. nickel

Plating B—.000015 [0.00038] gold in mating area, .000100 [0.00254] min. tin in solder area, with entire contact underplated .000050 [0.00127] min. nickel

Plating C—.000030 [0.00076] gold in mating area, .000100 [0.00254] min. tin in solder area, with entire contact underplated .000050 [0.00127] min. nickel

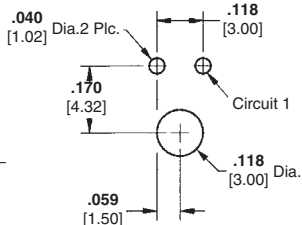
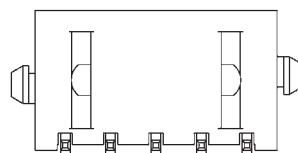
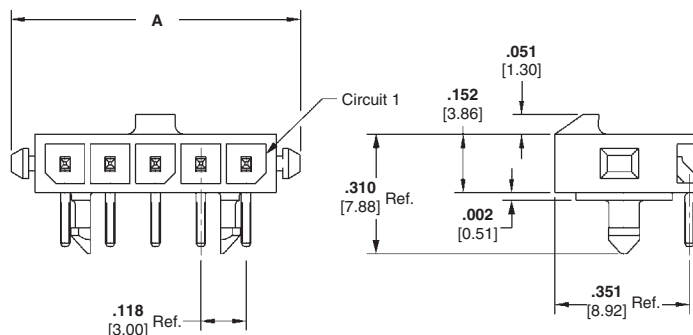

Recommended PC Board Layout 2 Position*

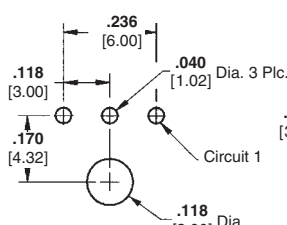

Recommended PC Board Layout 3 Position*

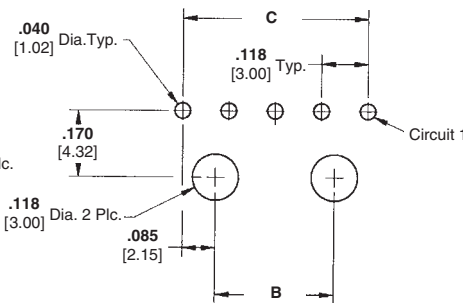

Recommended PC Board Layout 4-12 Position*

Related Product Data

Mateable Housings:

Single Row Receptacle Housing—page 23

Number of Circuits	Dimensions			Header Part Numbers			Mates with Receptacle Housing Part Number
	A	B	C	Plating A	Plating B	Plating C	
2	.399 10.14	—	—	2-1445055-2	2-1445089-2	2-1445098-2	1445022-2
3	.517 13.14	—	—	2-1445055-3	2-1445089-3	2-1445098-3	1445022-3
4	.635 16.14	.185 4.70	.354 9.00	2-1445055-4	2-1445089-4	2-1445098-4	1445022-4
5	.754 19.14	.303 7.70	.472 12.00	2-1445055-5	2-1445089-5	2-1445098-5	1445022-5
6	.871 22.14	.421 10.70	.591 15.00	2-1445055-6	2-1445089-6	2-1445098-6	1445022-6
7	.990 25.14	.539 13.70	.709 18.00	2-1445055-7	2-1445089-7	2-1445098-7	1445022-7
8	1.108 28.14	.657 16.70	.827 21.00	2-1445055-8	2-1445089-8	2-1445098-8	1445022-8
9	1.226 31.14	.775 19.70	.945 24.00	2-1445055-9	2-1445089-9	2-1445098-9	1445022-9
10	1.344 34.14	.894 22.70	1.063 27.00	3-1445055-0	3-1445089-0	3-1445098-0	1-1445022-0
11	1.462 37.14	1.012 25.70	1.181 30.00	3-1445055-1	3-1445089-1	3-1445098-1	1-1445022-1
12	1.580 40.14	1.300 28.70	1.299 33.00	3-1445055-2	3-1445089-2	3-1445098-2	1-1445022-2

*Recommended PC Board thickness .062 [1.57]. Always consult customer drawing for PC Board layout dimensions.

Note: All part numbers are RoHS Compliant.

Right-Angle Header Assemblies (Continued)

Single Row, Surface Mount, with Metal Through-Hole Hold-down

Material and Finish

Housing — High Temperature Nylon, Black

Flammability Rating — UL 94V-0

Contacts — Brass

Plating A — .000100 [0.00254] min. tin over .000050 [0.00127] min. nickel

Plating B — .000015 [0.00038] gold in mating area, .000100 [0.00254] min. tin in solder area, with entire contact underplated .000050 [0.00127] min. nickel

Plating C — .000030 [0.00076] gold in mating area, .000100 [0.00254] min. tin in solder area, with entire contact underplated .000050 [0.00127] min. nickel

Hold-downs — Phosphor Bronze, .000100 [0.00254] min. tin over .000050 [0.00127] min. nickel

Related Product Data

Mateable Housings:

Single Row Receptacle Housing—
page 23

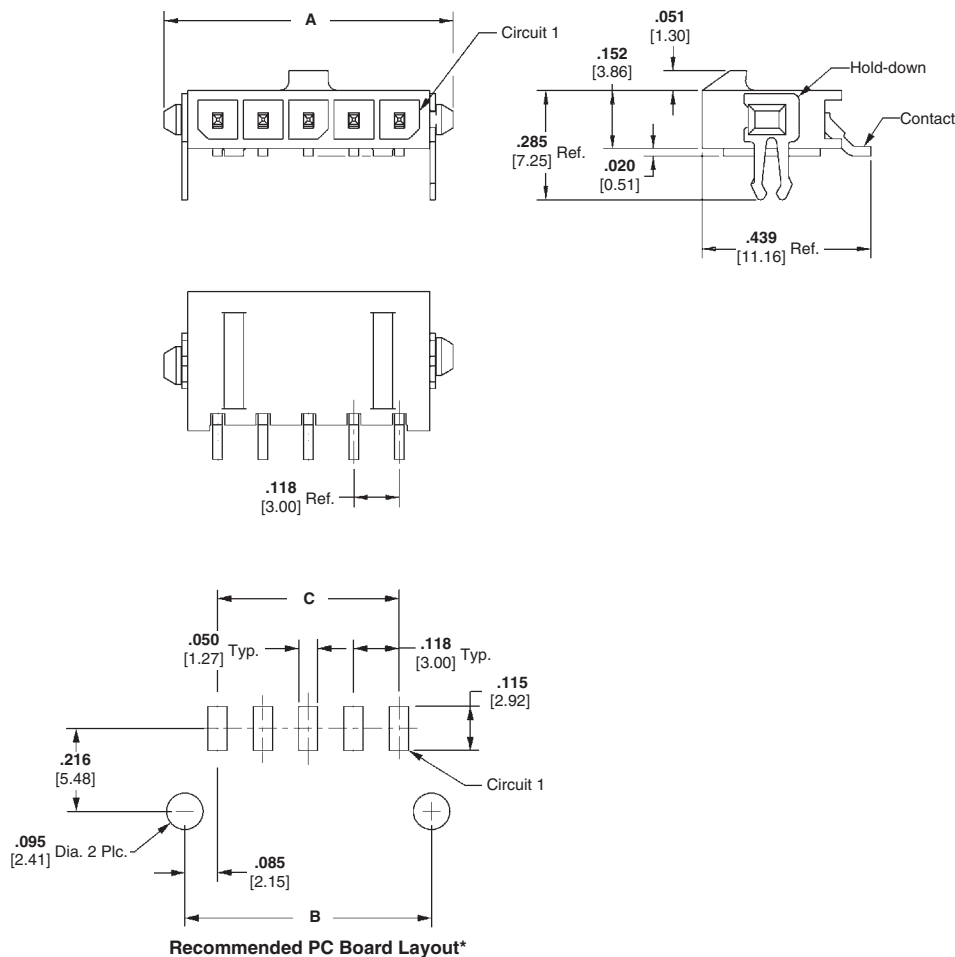

Number of Circuits	Dimensions			Header Part Numbers			Mates with Receptacle Housing Part Number
	A	B	C	Plating A	Plating B	Plating C	
2	.394 10.00	.293 7.43	.118 3.00	2-1445056-2	2-1445090-2	2-1445099-2	1445022-2
3	.512 13.00	.411 10.43	.236 6.00	2-1445056-3	2-1445090-3	2-1445099-3	1445022-3
4	.630 16.00	.529 13.43	.354 9.00	2-1445056-4	2-1445090-4	2-1445099-4	1445022-4
5	.748 19.00	.647 16.43	.472 12.00	2-1445056-5	2-1445090-5	2-1445099-5	1445022-5
6	.866 22.00	.765 19.43	.591 15.00	2-1445056-6	2-1445090-6	2-1445099-6	1445022-6
7	.984 25.00	.883 22.43	.709 18.00	2-1445056-7	2-1445090-7	2-1445099-7	1445022-7
8	1.102 28.00	1.001 25.43	.827 21.00	2-1445056-8	2-1445090-8	2-1445099-8	1445022-8
9	1.220 31.00	1.119 28.43	0.945 24.00	2-1445056-9	2-1445090-9	2-1445099-9	1445022-9
10	1.339 34.00	1.237 31.43	1.063 27.00	3-1445056-0	3-1445090-0	3-1445099-0	1-1445022-0
11	1.457 37.00	1.356 34.43	1.181 30.00	3-1445056-1	3-1445090-1	3-1445099-1	1-1445022-1
12	1.575 40.00	1.474 37.43	1.299 33.00	3-1445056-2	3-1445090-2	3-1445099-2	1-1445022-2

*Recommended PC Board thickness .062 [1.57]. Always consult customer drawing for PC Board layout dimensions.

Note: All part numbers are RoHS Compliant.

Right-Angle Header Assemblies (Continued)

Single Row, Surface Mount, with Surface Mount Hold-down

Material and Finish

Housing — High Temperature Nylon, Black

Flammability Rating — UL 94V-0

Contacts—Brass

Plating A—.000100 [0.00254] min. tin over .000050 [0.00127] min. nickel

Plating B—.000015 [0.00038] gold in mating area, .000100 [0.00254] min. tin in solder area, with entire contact underplated .000050 [0.00127] min. nickel

Plating C—.000030 [0.00076] gold in mating area, .000100 [0.00254] min. tin in solder area, with entire contact underplated .000050 [0.00127] min. nickel

Hold-downs—Phosphor Bronze, .000100 [0.00254] min. tin over .000050 [0.00127] min. nickel

Related Product Data

Mateable Housings:

Single Row Receptacle Housing—
page 23

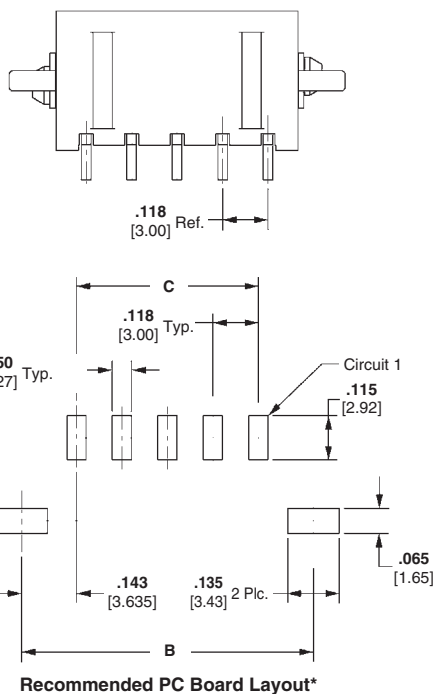
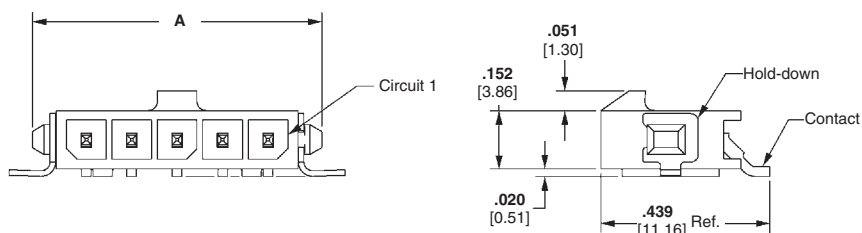

Recommended PC Board Layout*

Number of Circuits	Dimensions			Header Part Numbers			Mates with Receptacle Housing Part Number
	A	B	C	Plating A	Plating B	Plating C	
2	.394 10.00	.410 10.41	.118 3.00	2-1445057-2	2-1445091-2	2-1445100-2	1445022-2
3	.512 13.00	.528 13.41	.236 6.00	2-1445057-3	2-1445091-3	2-1445100-3	1445022-3
4	.630 16.00	.646 16.41	.354 9.00	2-1445057-4	2-1445091-4	2-1445100-4	1445022-4
5	.748 19.00	.764 19.41	.472 12.00	2-1445057-5	2-1445091-5	2-1445100-5	1445022-5
6	.866 22.00	.882 22.41	.591 15.00	2-1445057-6	2-1445091-6	2-1445100-6	1445022-6
7	.984 25.00	1.000 25.41	.709 18.00	2-1445057-7	2-1445091-7	2-1445100-7	1445022-7
8	1.102 28.00	1.119 28.41	.827 21.00	2-1445057-8	2-1445091-8	2-1445100-8	1445022-8
9	1.220 31.00	1.237 31.41	.945 24.00	2-1445057-9	2-1445091-9	2-1445100-9	1445022-9
10	1.339 34.00	1.355 34.41	1.063 27.00	3-1445057-0	3-1445091-0	3-1445100-0	1-1445022-0
11	1.457 37.00	1.472 37.41	1.181 30.00	3-1445057-1	3-1445091-1	3-1445100-1	1-1445022-1
12	1.575 40.00	1.591 40.41	1.299 33.00	3-1445057-2	3-1445091-2	3-1445100-2	1-1445022-2

*Always consult customer drawing for PC Board layout dimensions.

Note: All part numbers are RoHS Compliant.

Right-Angle Header Assemblies (Continued)

Single Row, Surface Mount, with Plastic Boardlock

Material and Finish

Housing — High Temperature Nylon, Black

Flammability Rating — UL 94V-0

Contacts — Brass

Plating A — .000100 [0.00254] min. tin over .000050 [0.00127] min. nickel

Plating B — .000015 [0.00038] gold in mating area, .000100 [0.00254] min. tin in solder area, with entire contact underplated .000050 [0.00127] min. nickel

Plating C — .000030 [0.00076] gold in mating area, .000100 [0.00254] min. tin in solder area, with entire contact underplated .000050 [0.00127] min. nickel

Related Product Data

Mateable Housings:

Single Row Receptacle Housing— page 23

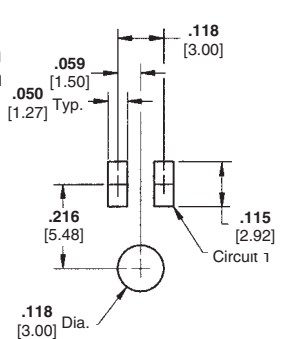
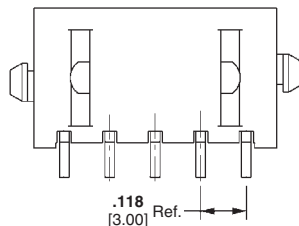
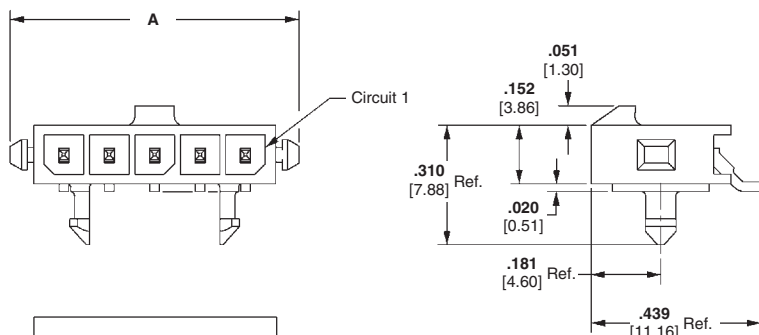

Recommended PC Board Layout *
2 Position

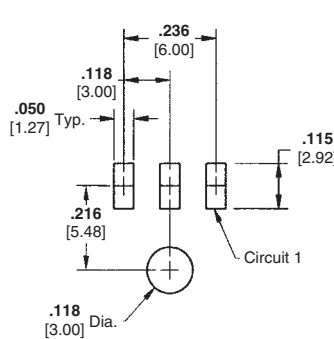

Recommended PC Board Layout *
3 Position

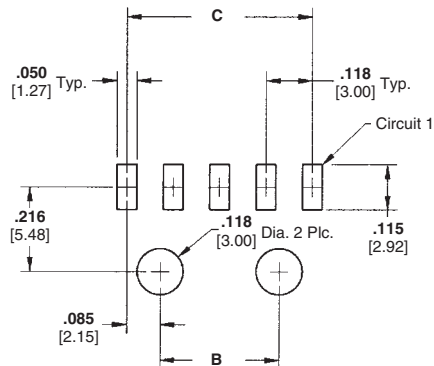

Recommended PC Board Layout*
4-12 Positions

Number of Circuits	Dimensions			Header Part Numbers			Mates with Receptacle Housing Part Number
	A	B	C	Plating A	Plating B	Plating C	
2	.394 10.00	—	—	2-1445058-2	2-1445092-2	2-1445101-2	1445022-2
3	.512 13.00	—	—	2-1445058-3	2-1445092-3	2-1445101-3	1445022-3
4	.630 16.00	.185 4.70	.354 9.00	2-1445058-4	2-1445092-4	2-1445101-4	1445022-4
5	.748 19.00	.303 7.70	.472 12.00	2-1445058-5	2-1445092-5	2-1445101-5	1445022-5
6	.866 22.00	.421 10.70	.591 15.00	2-1445058-6	2-1445092-6	2-1445101-6	1445022-6
7	.984 25.00	.539 13.70	.709 18.00	2-1445058-7	2-1445092-7	2-1445101-7	1445022-7
8	1.102 28.00	.657 16.70	.827 21.00	2-1445058-8	2-1445092-8	2-1445101-8	1445022-8
9	1.220 31.00	.776 19.70	.945 24.00	2-1445058-9	2-1445092-9	2-1445101-9	1445022-9
10	1.339 34.00	.894 22.70	1.063 27.00	3-1445058-0	3-1445092-0	3-1445101-0	1-1445022-0
11	1.457 37.00	1.012 25.70	1.181 30.00	3-1445058-1	3-1445092-1	3-1445101-1	1-1445022-1
12	1.575 40.00	1.130 28.70	1.299 33.00	3-1445058-2	3-1445092-2	3-1445101-2	1-1445022-2

*Recommended PC Board thickness .062 [1.57]. Always consult customer drawing for PC Board layout dimensions.

Note: All part numbers are RoHS Compliant.

Right-Angle Header Assemblies (Continued)

Dual Row, Through-Hole, with Metal Through-Hole Hold-down

Material and Finish

Housing — High Temperature Nylon, Black

Flammability Rating — UL 94V-0

Contacts — Brass

Plating A — .000100 [0.00254] min. tin over .000050 [0.00127] min. nickel

Plating B — .000015 [0.00038] gold in mating area, .000100 [0.00254] min. tin in solder area, with entire contact underplated .000050 [0.00127] min. nickel

Plating C — .000030 [0.00076] gold in mating area, .000100 [0.00254] min. tin in solder area, with entire contact underplated .000050 [0.00127] min. nickel

Hold-downs — Phosphor Bronze, .000100 [0.00254] min. tin over .000050 [0.00127] min. nickel

Related Product Data

Mateable Housings:

Dual Row Receptacle Housing—page 24

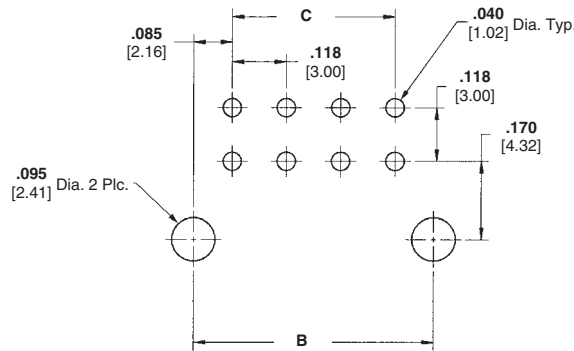
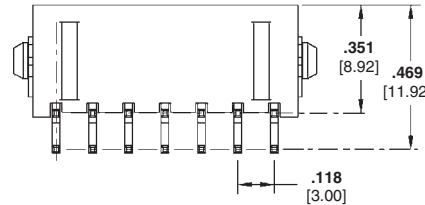
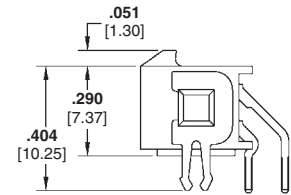
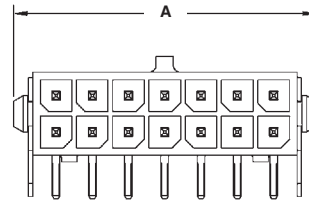

Recommended PC Board Layout*

Number of Circuits	Dimensions			Header Part Numbers			Mates with Receptacle Housing Part Number
	A	B	C	Plating A	Plating B	Plating C	
2	.276 7.00	.169 4.30	—	3-794677-2	3-794678-2	3-794679-2	794617-2
4	.394 10.00	.287 7.30	.118 3.00	3-794677-4	3-794678-4	3-794679-4	794617-4
6	.512 13.00	.406 10.30	.236 6.00	3-794677-6	3-794678-6	3-794679-6	794617-6
8	.630 16.00	.524 13.30	.354 9.00	3-794677-8	3-794678-8	3-794679-8	794617-8
10	.748 19.00	.642 16.30	.472 12.00	4-794677-0	4-794678-0	4-794679-0	1-794617-0
12	.866 22.00	.760 19.30	.591 15.00	4-794677-2	4-794678-2	4-794679-2	1-794617-2
14	.984 25.00	.878 22.30	.709 18.00	4-794677-4	4-794678-4	4-794679-4	1-794617-4
16	1.102 28.00	.996 25.30	.827 21.00	4-794677-6	4-794678-6	4-794679-6	1-794617-6
18	1.220 31.00	1.114 28.30	.945 24.00	4-794677-8	4-794678-8	4-794679-8	1-794617-8
20	1.339 34.00	1.232 31.30	1.063 27.00	5-794677-0	5-794678-0	5-794679-0	2-794617-0
22	1.457 37.00	1.350 34.30	1.181 30.00	5-794677-2	5-794678-2	5-794679-2	2-794617-2
24	1.575 40.00	1.469 37.30	1.299 33.00	5-794677-4	5-794678-4	5-794679-4	2-794617-4

*Recommended PC Board thickness .062 [1.57]. Always consult customer drawing for PC Board layout dimensions.

Note: All part numbers are RoHS Compliant.

Electronics

Micro MATE-N-LOK 3mm Connector System (Continued)

Right-Angle Header Assemblies (Continued)

Dual Row, Through-Hole, with Plastic Boardlock

Material and Finish

Housing — High Temperature Nylon, Black

Flammability Rating — UL 94V-0

Contacts—Brass

Plating A - .000100 [0.00254] min. tin over .000050 [0.00127] min. nickel

Plating B—.000015 [0.00038] gold in mating area, .000100 [0.00254] min. tin in solder area, with entire contact underplated .000050 [0.00127] min. nickel

Plating C—.000030 [0.00076] gold in mating area, .000100 [0.00254] min. tin in solder area, with entire contact underplated .000050 [0.00127] min. nickel

Related Product Data

Mateable Housings:

Dual Row Receptacle Housing—page 24

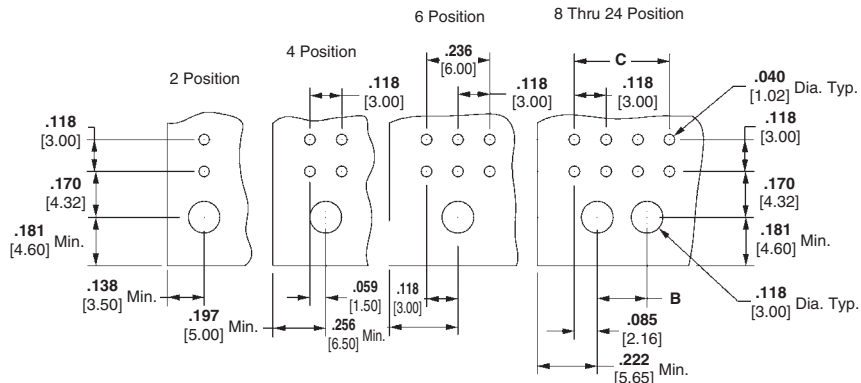
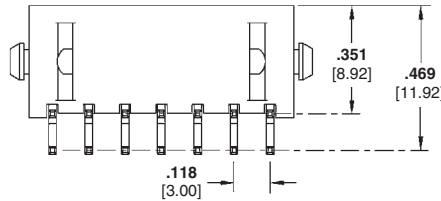
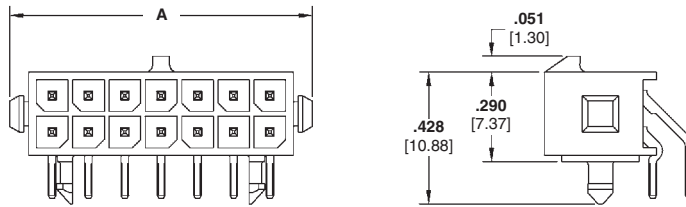

Recommended PC Board Layout*

Number of Circuits	Dimensions			Header Part Numbers			Mates with Receptacle Housing Part Number
	A	B	C	Plating A	Plating B	Plating C	
2	.276 7.00	—	—	3-794618-2	3-794619-2	3-794620-2	794617-2
4	.394 10.00	—	.118 3.00	3-794618-4	3-794619-4	3-794620-4	794617-4
6	.512 13.00	—	.236 6.00	3-794618-6	3-794619-6	3-794620-6	794617-6
8	.630 16.00	.185 4.70	.354 9.00	3-794618-8	3-794619-8	3-794620-8	794617-8
10	.748 19.00	.303 7.70	.472 12.00	4-794618-0	4-794619-0	4-794620-0	1-794617-0
12	.866 22.00	.421 10.70	.591 15.00	4-794618-2	4-794619-2	4-794620-2	1-794617-2
14	.984 25.00	.539 13.70	.709 18.00	4-794618-4	4-794619-4	4-794620-4	1-794617-4
16	1.102 28.00	.657 16.70	.827 21.00	4-794618-6	4-794619-6	4-794620-6	1-794617-6
18	1.220 31.00	.776 19.70	.945 24.00	4-794618-8	4-794619-8	4-794620-8	1-794617-8
20	1.339 34.00	.894 22.70	1.063 27.00	5-794618-0	5-794619-0	5-794620-0	2-794617-0
22	1.457 37.00	1.012 25.70	1.181 30.00	5-794618-2	5-794619-2	5-794620-2	2-794617-2
24	1.575 40.00	1.130 28.70	1.299 33.00	5-794618-4	5-794619-4	5-794620-4	2-794617-4

*Recommended PC Board thickness .062 [1.57]. Always consult customer drawing for PC Board layout dimensions.

Note: All part numbers are RoHS Compliant.

High Density
.118 [3.00] Centerline

Micro MATE-N-LOK 3mm Connector System (Continued)

Right-Angle Header Assemblies (Continued)

Dual Row, Surface Mount, with Metal Through-Hole Hold-down

Material and Finish

Housing — High Temperature Nylon, Black

Flammability Rating — UL 94V-0

Contacts—Brass

Plating A—.000100 [0.00254] min. tin over .000050 [0.00127] min. nickel

Plating B—.000015 [0.00038] gold in mating area, .000100 [0.00254] min. tin in solder area, with entire contact underplated .000050 [0.00127] min. nickel

Plating C—.000030 [0.00076] gold in mating area, .000100 [0.00254] min. tin in solder area, with entire contact underplated .000050 [0.00127] min. nickel

Hold-downs—Phosphor Bronze, .000100 [0.00254] min. tin over .000050 [0.00127] min. nickel

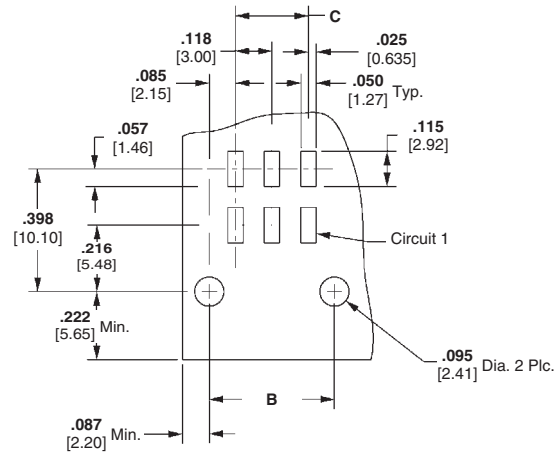
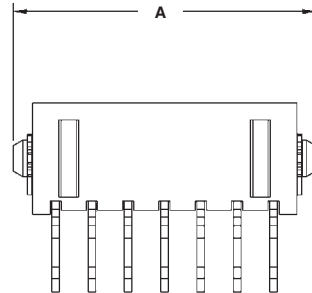
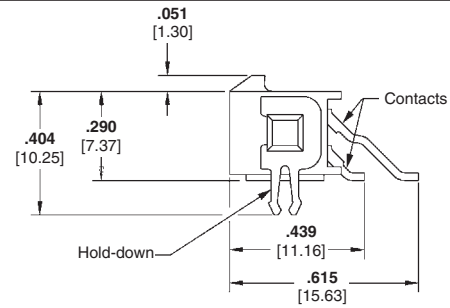
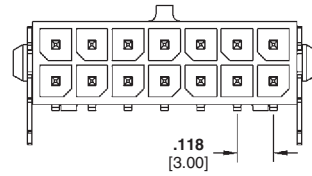

Recommended PC Board Layout*

Related Product Data

Mateable Housings:

Dual Row Receptacle Housing—page 24

Number of Circuits	Dimensions			Header Part Numbers			Mates with Receptacle Housing Part Number
	A	B	C	Plating A	Plating B	Plating C	
2	.276 7.00	.169 4.30	—	3-794624-2	3-794625-2	3-794626-2	794617-2
4	.394 10.00	.287 7.30	.118 3.00	3-794624-4	3-794625-4	3-794626-4	794617-4
6	.512 13.00	.406 10.30	.236 6.00	3-794624-6	3-794625-6	3-794626-6	794617-6
8	.630 16.00	.524 13.30	.354 9.00	3-794624-8	3-794625-8	3-794626-8	794617-8
10	.748 19.00	.642 16.30	.472 12.00	4-794624-0	4-794625-0	4-794626-0	1-794617-0
12	.866 22.00	.760 19.30	.591 15.00	4-794624-2	4-794625-2	4-794626-2	1-794617-2
14	.984 25.00	.878 22.30	.709 18.00	4-794624-4	4-794625-4	4-794626-4	1-794617-4
16	1.102 28.00	.996 25.30	.827 21.00	4-794624-6	4-794625-6	4-794626-6	1-794617-6
18	1.220 31.00	1.114 28.30	.945 24.00	4-794624-8	4-794625-8	4-794626-8	1-794617-8
20	1.339 34.00	1.232 31.30	1.063 27.00	5-794624-0	5-794625-0	5-794626-0	2-794617-0
22	1.457 37.00	1.350 34.30	1.181 30.00	5-794624-2	5-794625-2	5-794626-2	2-794617-2
24	1.575 40.00	1.469 37.30	1.299 33.00	5-794624-4	5-794625-4	5-794626-4	2-794617-4

*Recommended PC Board thickness .062 [1.57]. Always consult customer drawing for PC Board layout dimensions.

Note: All part numbers are RoHS Compliant.

Micro MATE-N-LOK 3mm Connector System (Continued)

Right-Angle Header Assemblies (Continued)
Dual Row, Surface Mount, with Plastic Boardlock

Material and Finish

Housing — High Temperature Nylon, Black

Flammability Rating — UL 94V-0

Contacts — Brass

Plating A — .000100 [0.00254] min. tin over .000050 [0.00127] min. nickel

Plating B — .000015 [0.00038] gold in mating area, .000100 [0.00254] min. tin in solder area, with entire contact underplated .000050 [0.00127] min. nickel

Plating C — .000030 [0.00076] gold in mating area, .000100 [0.00254] min. tin in solder area, with entire contact underplated .000050 [0.00127] min. nickel

Related Product Data

Mateable Housings:

Dual Row Receptacle Housing—page 24

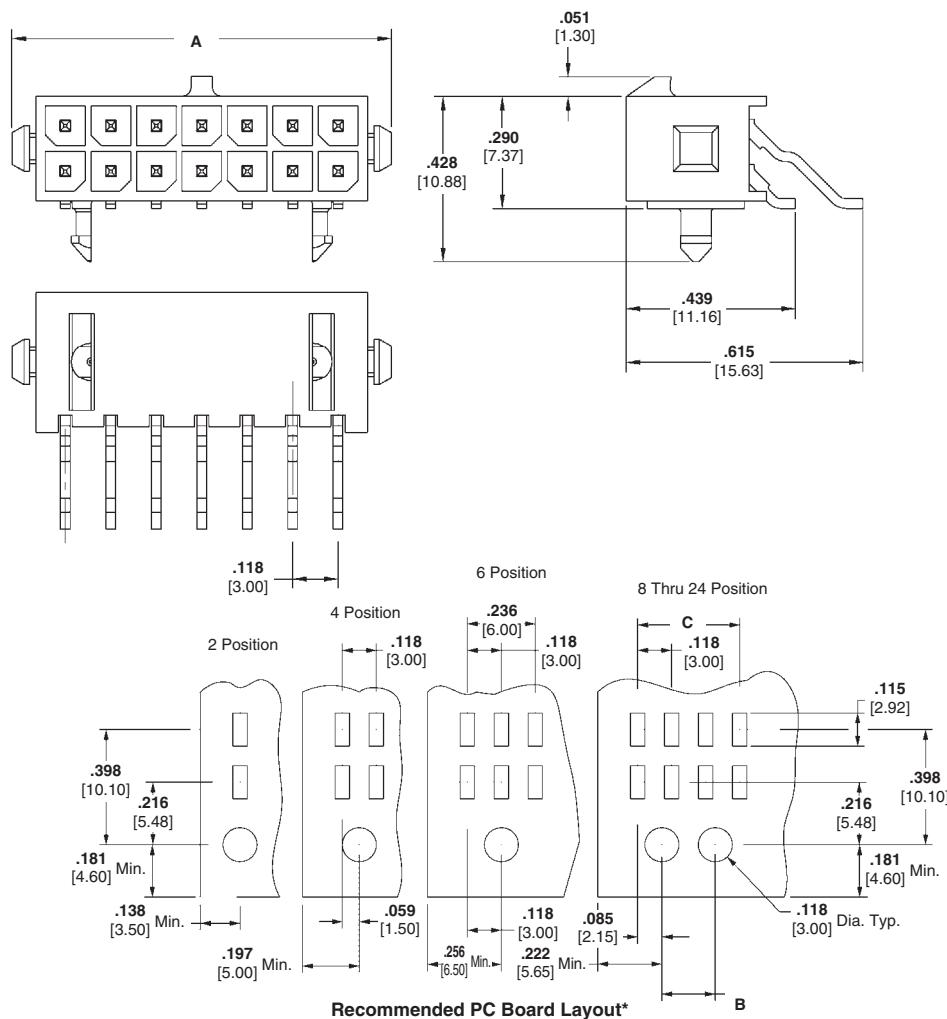

Number of Circuits	Dimensions			Header Part Numbers			Mates with Receptacle Housing Part Number
	A	B	C	Plating A	Plating B	Plating C	
2	.276 7.00	—	—	3-794621-2	3-794622-2	3-794623-2	794617-2
4	.394 10.00	—	.118 3.00	3-794621-4	3-794622-4	3-794623-4	794617-4
6	.512 13.00	—	.236 6.00	3-794621-6	3-794622-6	3-794623-6	794617-6
8	.630 16.00	.185 4.70	.354 9.00	3-794621-8	3-794622-8	3-794623-8	794617-8
10	.748 19.00	.303 7.70	.472 12.00	4-794621-0	4-794622-0	4-794623-0	1-794617-0
12	.866 22.00	.421 10.70	.591 15.00	4-794621-2	4-794622-2	4-794623-2	1-794617-2
14	.984 25.00	.539 13.70	.709 18.00	4-794621-4	4-794622-4	4-794623-4	1-794617-4
16	1.102 28.00	.657 16.70	.827 21.00	4-794621-6	4-794622-6	4-794623-6	1-794617-6
18	1.220 31.00	.776 19.70	.945 24.00	4-794621-8	4-794622-8	4-794623-8	1-794617-8
20	1.339 34.00	.894 22.70	1.063 27.00	5-794621-0	5-794622-0	5-794623-0	2-794617-0
22	1.457 37.00	1.012 25.70	1.181 30.00	5-794621-2	5-794622-2	5-794623-2	2-794617-2
24	1.575 40.00	1.130 28.70	1.299 33.00	5-794621-4	5-794622-4	5-794623-4	2-794617-4

*Recommended PC Board thickness .062 [1.57]. Always consult customer drawing for PC Board layout dimensions.

Note: All part numbers are RoHS Compliant.

Right-Angle Header Assemblies (Continued)

Dual Row, Surface Mount, with Surface Mount Hold-down

Material and Finish

Housing — High Temperature Nylon, Black

Flammability Rating — UL 94V-0

Contacts—Brass

Plating A—.000100 [0.00254] min. tin over .000050 [0.00127] min. nickel

Plating B—.000015 [0.00038] gold in mating area, .000100 [0.00254] min. tin in solder area, with entire contact underplated .000050 [0.00127] min. nickel

Plating C—.000030 [0.00076] gold in mating area, .000100 [0.00254] min. tin in solder area, with entire contact underplated .000050 [0.00127] min. nickel

Hold-downs—Phosphor Bronze, .000100 [0.00254] min. tin over .000050 [0.00127] min. nickel

Related Product Data

Mateable Housings:

Dual Row Receptacle Housing—page 24

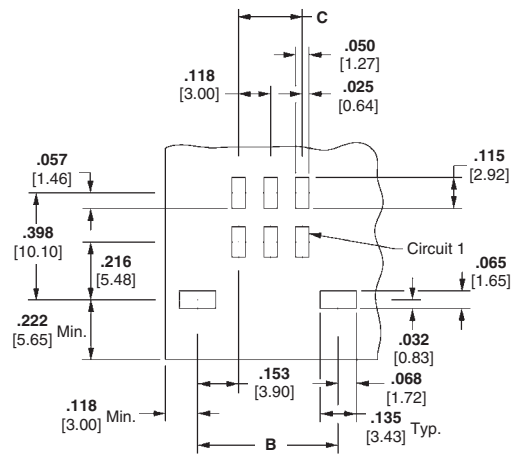
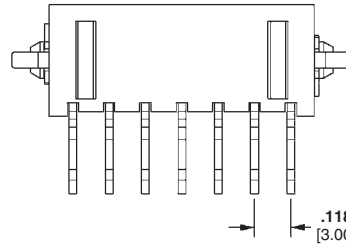
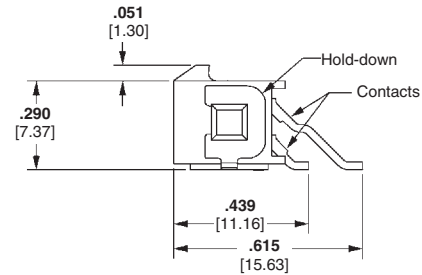
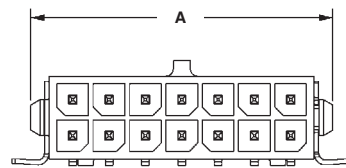

Recommended PC Board Layout*

Number of Circuits	Dimensions			Header Part Numbers			Mates with Receptacle Housing Part Number
	A	B	C	Plating A	Plating B	Plating C	
2	.276 7.00	.276 7.27	—	3-794627-2	3-794628-2	3-794629-2	794617-2
4	.394 10.00	.394 10.27	.118 3.00	3-794627-4	3-794628-4	3-794629-4	794617-4
6	.512 13.00	.512 13.27	.236 6.00	3-794627-6	3-794628-6	3-794629-6	794617-6
8	.630 16.00	.630 16.27	.354 9.00	3-794627-8	3-794628-8	3-794629-8	794617-8
10	.748 19.00	.748 19.27	.472 12.00	4-794627-0	4-794628-0	4-794629-0	1-794617-0
12	.866 22.00	.866 22.27	.591 15.00	4-794627-2	4-794628-2	4-794629-2	1-794617-2
14	.984 25.00	.984 25.27	.709 18.00	4-794627-4	4-794628-4	4-794629-4	1-794617-4
16	1.102 28.00	1.102 28.27	.827 21.00	4-794627-6	4-794628-6	4-794629-6	1-794617-6
18	1.220 31.00	1.220 31.27	.945 24.00	4-794627-8	4-794628-8	4-794629-8	1-794617-8
20	1.339 34.00	1.339 34.27	1.063 27.00	5-794627-0	5-794628-0	5-794629-0	2-794617-0
22	1.457 37.00	1.457 37.27	1.181 30.00	5-794627-2	5-794628-2	5-794629-2	2-794617-2
24	1.575 40.00	1.575 40.27	1.299 33.00	5-794627-4	5-794628-4	5-794629-4	2-794617-4

*Always consult customer drawing for PC Board layout dimensions.

Note: All part numbers are RoHS Compliant.