

Embase - MSTBA 2,5/ 5-G - 1757501

Please be informed that the data shown in this PDF Document is generated from our Online Catalog. Please find the complete data in the user's documentation. Our General Terms of Use for Downloads are valid (<http://download.phoenixcontact.com>)



Embase, Intensité nominale: 12 A, Tension de référence (III/2): 320 V, Nbre. pôles: 5, Pas: 5 mm, Coloris: vert, Surface des contacts: étain, Montage: Soudage

L'illustration représente une version 10 pôles de l'article

Product Features

- Autres longueurs de picots sur demande
- Enfichage parallèle à l'axe du conducteur
- Type W avec rehausse
- Embase standard pour 320 V (III/2)

Key commercial data

package_quantity	250
GTIN	4017918030032

Technical data

Dimensions

Longueur	12 mm
Pas	5 mm
Cote a	20 mm
Dimensions des picots	1 x 1 mm
Diamètre de perçage	1,4 mm

Généralités

Famille d'articles	MSTBA 2,5/...-G
Groupe d'isolant	I
Tension de choc assignée (III/3)	4 kV
Tension de choc assignée (III/2)	4 kV
Tension de choc assignée (II/2)	4 kV
Tension de référence (III/3)	250 V
Tension assignée (III/2)	320 V
Tension assignée (II/2)	400 V
Connexion selon la norme	EN-VDE
Intensité nominale I_N	12 A
Courant de charge maximal	12 A
Matériau isolant	PA

Embase - MSTBA 2,5/ 5-G - 1757501

Technical data

Généralités

Classe d'inflammabilité selon UL 94	V0
Coloris	vert
Nombre de pôles	5

classifications

eCl@ss

eCl@ss 4.0	272607xx
eCl@ss 4.1	27260701
eCl@ss 5.0	27260701
eCl@ss 5.1	27260701
eCl@ss 6.0	27260704
eCl@ss 7.0	27440402
eCl@ss 8.0	27440402

ETIM

ETIM 3.0	EC001121
ETIM 4.0	EC002637
ETIM 5.0	EC002637

UNSPSC

UNSPSC 6.01	30211810
UNSPSC 7.0901	39121409
UNSPSC 11	39121409
UNSPSC 12.01	39121409
UNSPSC 13.2	39121409

approvals

CSA / UL Recognized / VDE Gutachten mit Fertigungsüberwachung / cUL Recognized / GOST / IECCE CB Scheme / GOST / CSA / CCA / cULus Recognized /

Approval details

		
Usegroups	B	D
Tension nominale UN	300 V	300 V
Intensité nominale IN	15 A	10 A
mm ² /AWG/kcmil		

Embase - MSTBA 2,5/ 5-G - 1757501

approvals

UL Recognized

Usegroups	B	D
Tension nominale UN	300 V	300 V
Intensité nominale IN	15 A	10 A
mm ² /AWG/kcmil		

VDE Gutachten mit Fertigungsüberwachung

Tension nominale UN	250 V
Intensité nominale IN	12 A
mm ² /AWG/kcmil	

cUL Recognized

Usegroups	B	D
Tension nominale UN	300 V	300 V
Intensité nominale IN	15 A	10 A
mm ² /AWG/kcmil		

GOST

IECEE CB Scheme

Tension nominale UN	250 V
Intensité nominale IN	12 A
mm ² /AWG/kcmil	

Embase - MSTBA 2,5/ 5-G - 1757501

approvals

Usegroups	B	D
Tension nominale UN	300 V	300 V
Intensité nominale IN	10 A	10 A
mm ² /AWG/kcmil		

CCA	
Tension nominale UN	250 V
Intensité nominale IN	12 A
mm ² /AWG/kcmil	



accessories

Cache

MSTB-BL - 1755477



Repère pour borne imprimé

SK 5/3,8:FORTL.ZAHLEN - 0804183



Élément de codage

CR-MSTB - 1734401



Embase - MSTBA 2,5/ 5-G - 1757501

Drawings

Gabarit de perçage

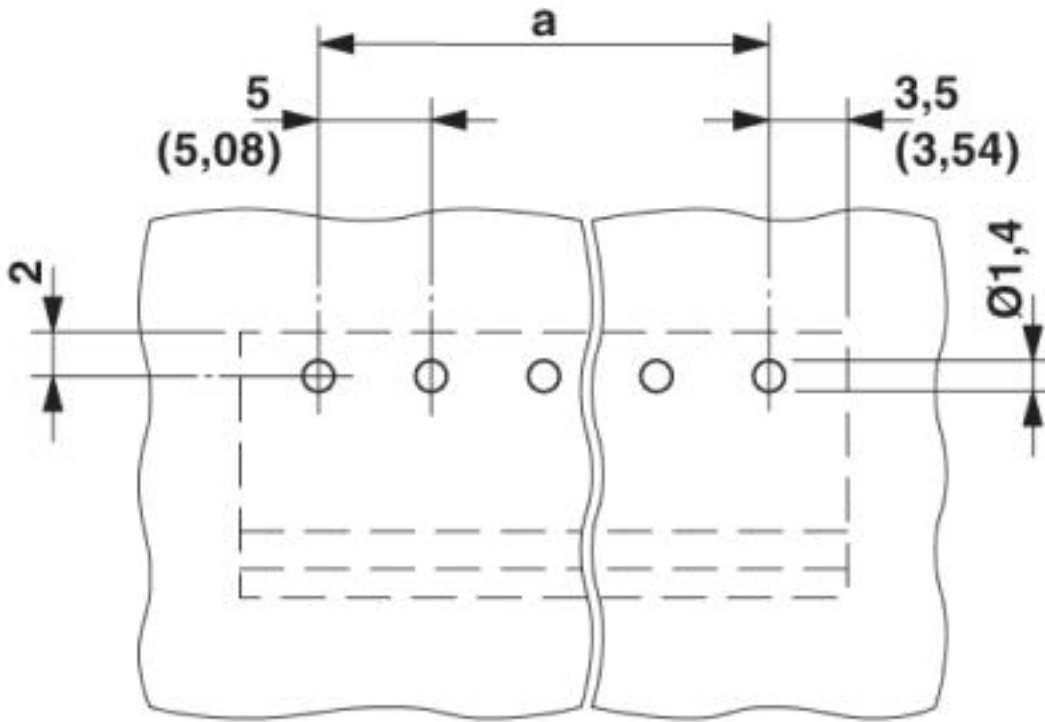

Embase - MSTBA 2,5/ 5-G - 1757501

Diagramme

Connecteur femelle : TMSTBP 2,5/5-ST(F)(-5,08)
Embase : MSTB(A) 2,5/5-G(F)(-5,08)

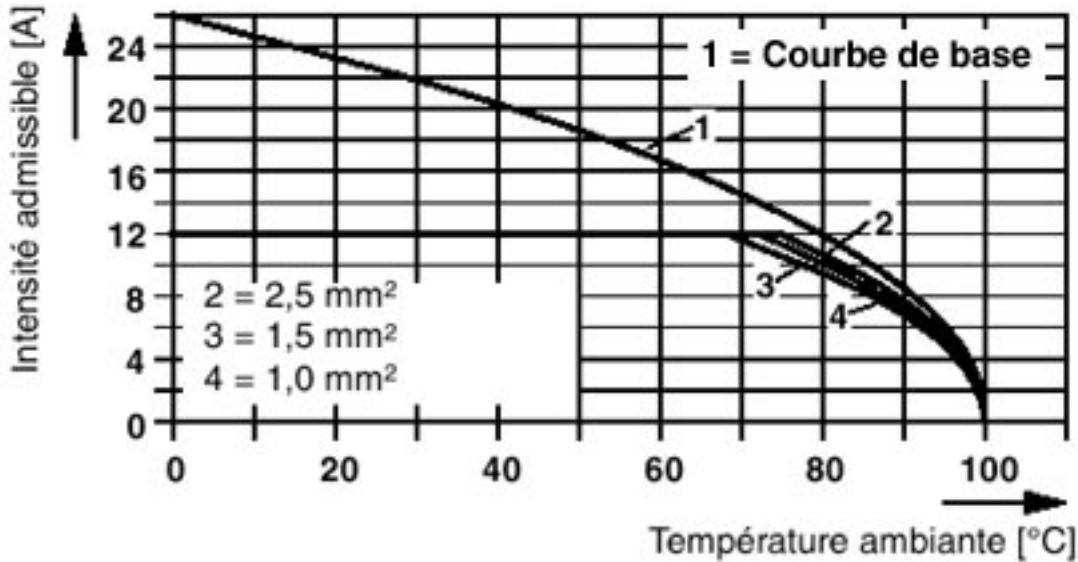

Diagramme

Connecteur femelle : MSTB 2,5/5-ST(F)(-5,08)
Embase : MSTBO 2,5/5-GR(L)(-5,08)

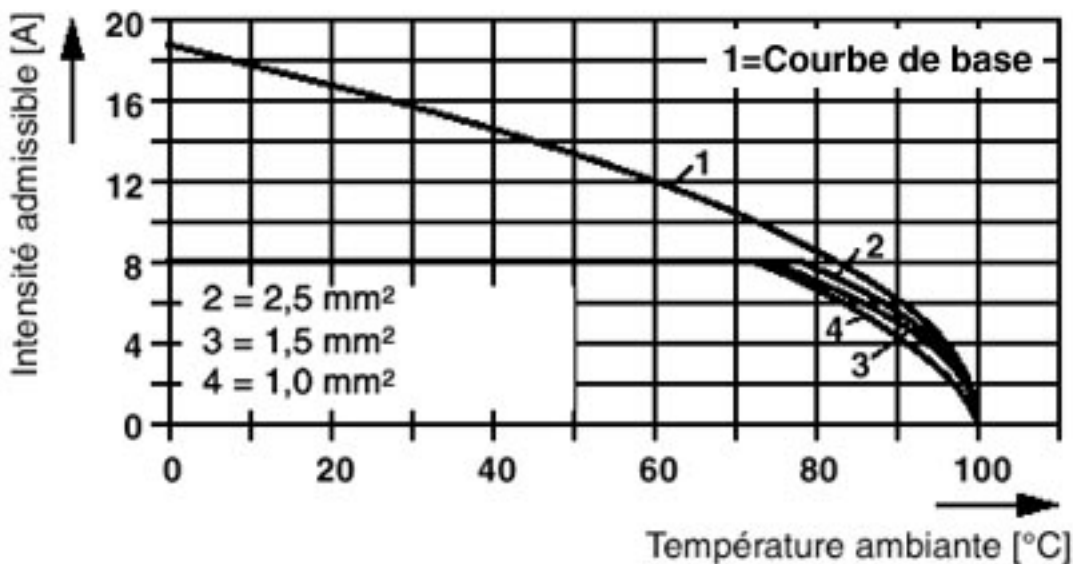

Embase - MSTBA 2,5/ 5-G - 1757501

Diagramme

Connecteur femelle : MSTBT 2,5/5-ST(F)-(-5,08)
Embase : MSTB(A) 2,5/5-G(F)-(-5,08)

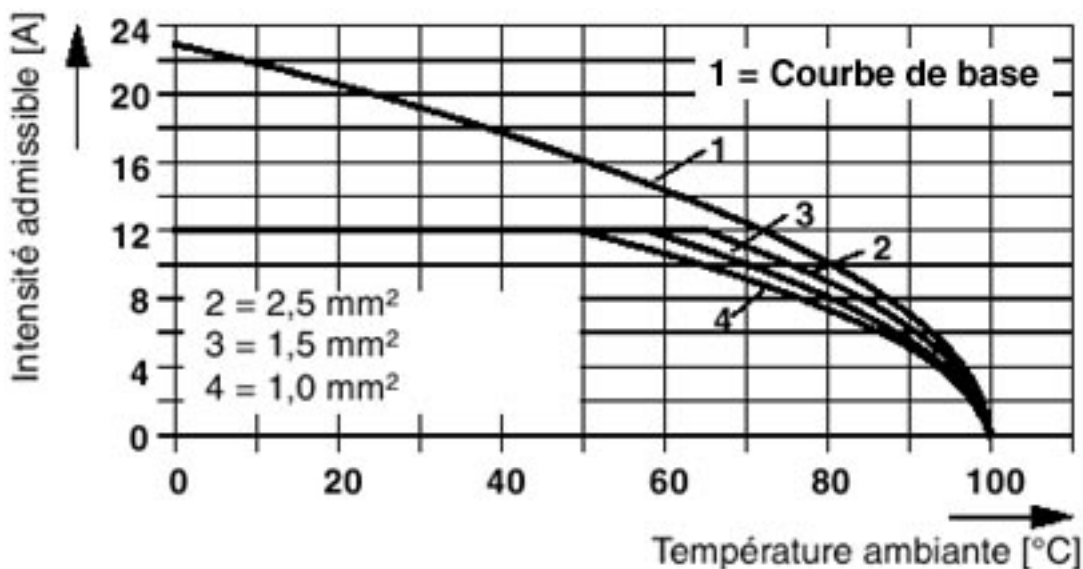

Diagramme

Connecteur femelle : SMSTB 2,5/5-ST(F)-(-5,08)
Embase : MSTB(A) 2,5/5-G(F)-(-5,08)

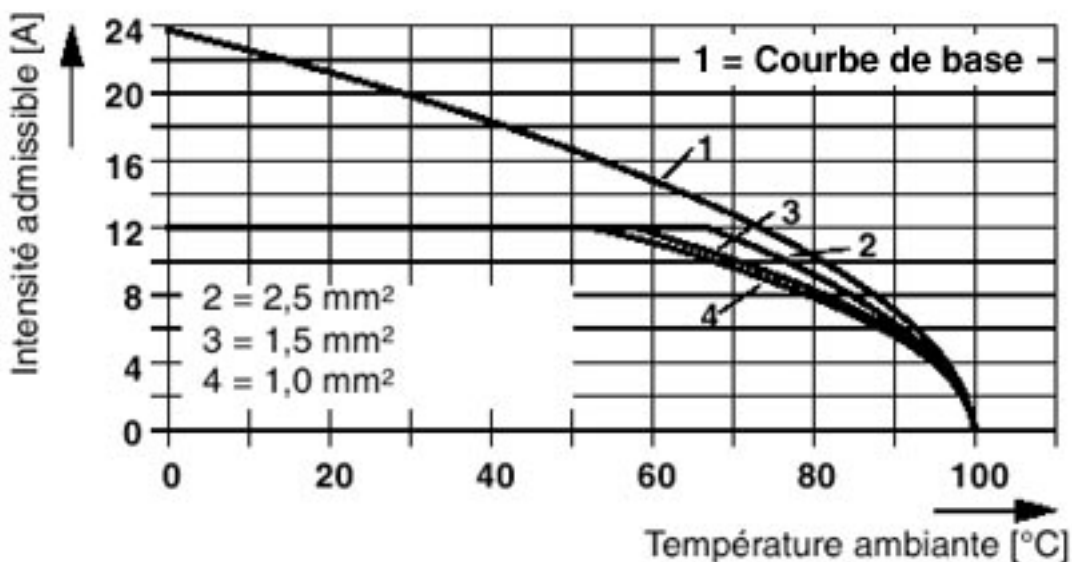

Embase - MSTBA 2,5/ 5-G - 1757501

Diagramme

Connecteur femelle : MVSTBR(W) 2,5/5-ST(F)-(-5,08)
Embase : MSTB(A) 2,5/5-G(F)-(5,08)

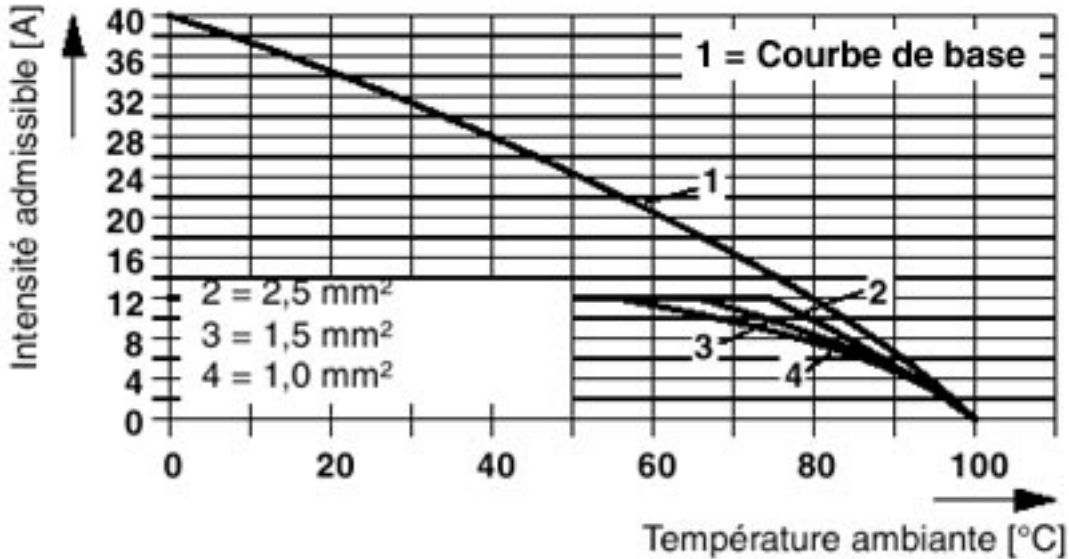

Diagramme

Connecteur femelle : FRONT-MSTB 2,5/5-ST(F)-(-5,08)
Embase : MSTB(A) 2,5/5-G(F)-(5,08)

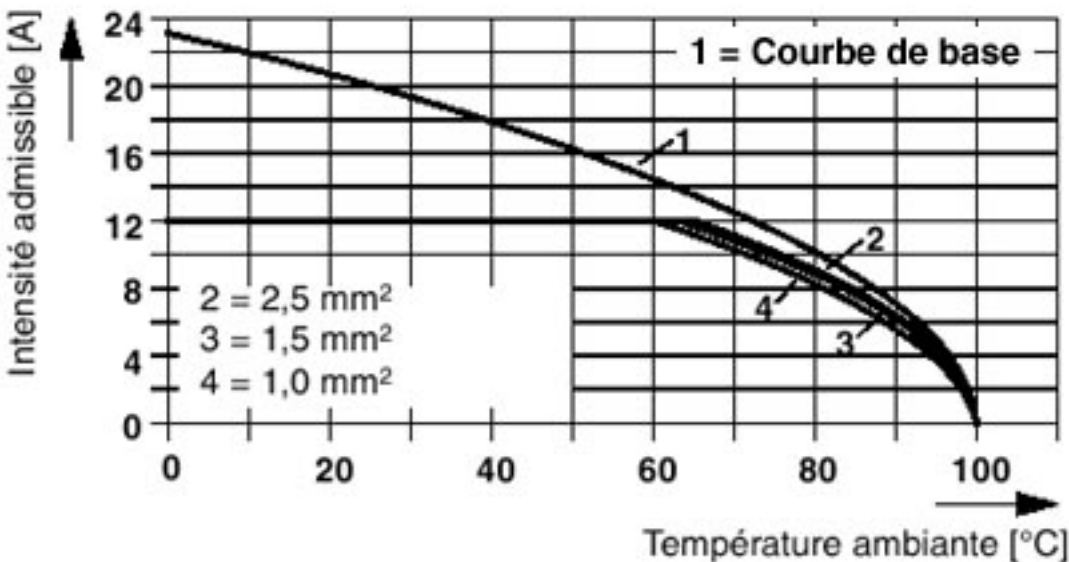

Embase - MSTBA 2,5/ 5-G - 1757501

Diagramme

Type : FKCVR 2,5/...-ST avec MSTBA 2,5/...-G

Dessin coté

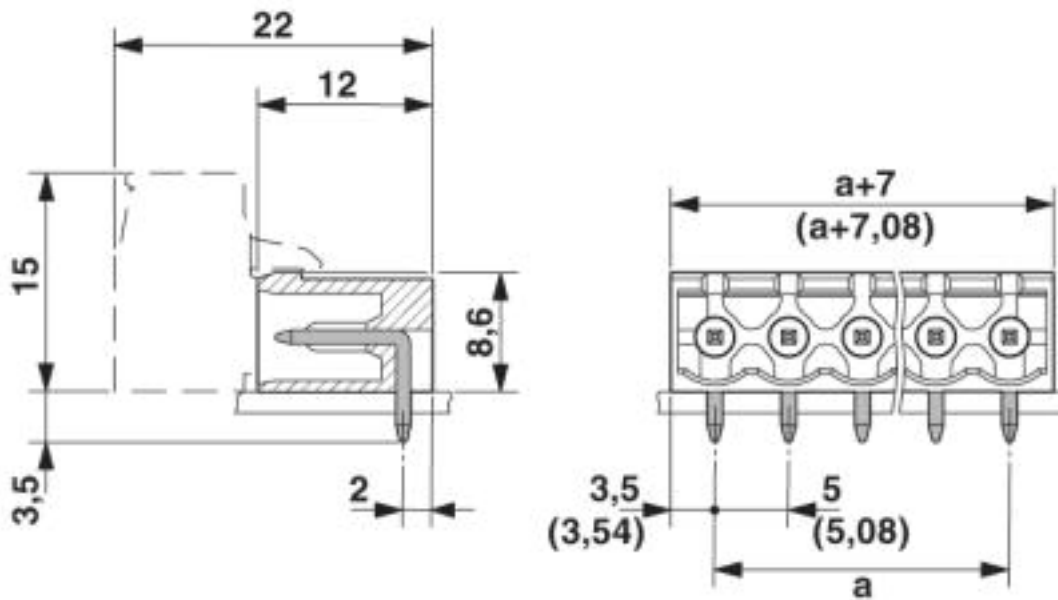

© Phoenix Contact 2013 - all rights reserved
<http://www.phoenixcontact.com>